

Delta Rostock mini G2& G2s

Building instruction

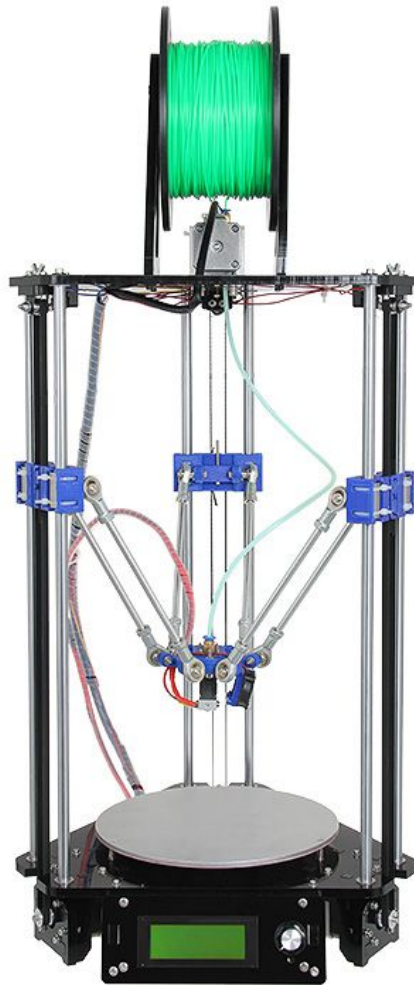

Safety Instructions

Building the printer will require a certain amount of physical dexterity, common sense and a thorough understanding of what you are doing. We have provided this detailed instruction to help you assemble it easily.

However ultimately we cannot be responsible for your health and safety whilst building or operating the printer, with that in mind be sure you are confident with what you are doing prior to commencing with building or buying. Read the entire manual to enable you to make an informed decision.

Building and operating involves electricity, so all necessary precautions should be taken and adhered to, the printer runs on 12V supplied by a certified power supply, so you shouldn't ever have to get involved with anything over 12V but bear in mind there can still be high currents involved and even at 12V they shouldn't be taken lightly.

High temperatures are involved with 3D Printing, the Extrusion nozzle of the hot end can run about 230°C, the heated bed runs 110°C and the molten plastic extruded will initially be at around 200°C, so special care and attention should be made when handling these parts of the printer during operation.

We wouldn't recommend leaving your printer running unattended, or at least until you are confident to do so. We cannot be held responsible for any loss, damage, threat, hurt or other negligent result from either building or using the printer.

Preparation

1. Unpack the kit and check if all parts are in the box and check the condition of each part, there might be some damage during shipping. To help you with this, there is BOM in the box and each bag was labeled with part number.
2. Contact our customer service immediately by email or through the website if you find any missing or damaged parts. And on the bottom of the BOM, there is a signature of reviewer, please take a picture of it and attach the picture in your mail.
3. Read through each chapter of these instructions to gain an over-all idea of what is involved and how long it might take, before starting on the work described.
4. Before you start, you can put all the part in order to save your time especially those screws and nuts. Do not mix them up.
5. Ensure you have the necessary skills to carry out the work, or enlist the help of someone who does.
6. Work on a big firm table or bench in a clean dry well-lit area.
7. This kit contains tiny parts; please keep them away from kids under 3.
8. Ask for help if you run into any problems - our contact details are on the website and we will always do our best to resolve any problems encountered.

Chapter1 Base Assembly

1.1 Motor end assembly

Name	Part NO.	qty	Pic
Stepper motor	53	3	
Pulley	33	3	
Motor holder	A3	3	
Motor holder support	A4	6	
Square nut	14	6	
M3 X 12 Screw	18	12	
M3 X 16 Screw	19	6	
M3 washer	5	18	

Step1. Mount the pulley on the motor shaft, one of the screws should be screwed on the cross section of the shaft. Do not screw too tight to turn smoothly.



Step2. Assemble A3 and 2 A4 together, and screw up with M3 X 16 screw and M3 square nut.

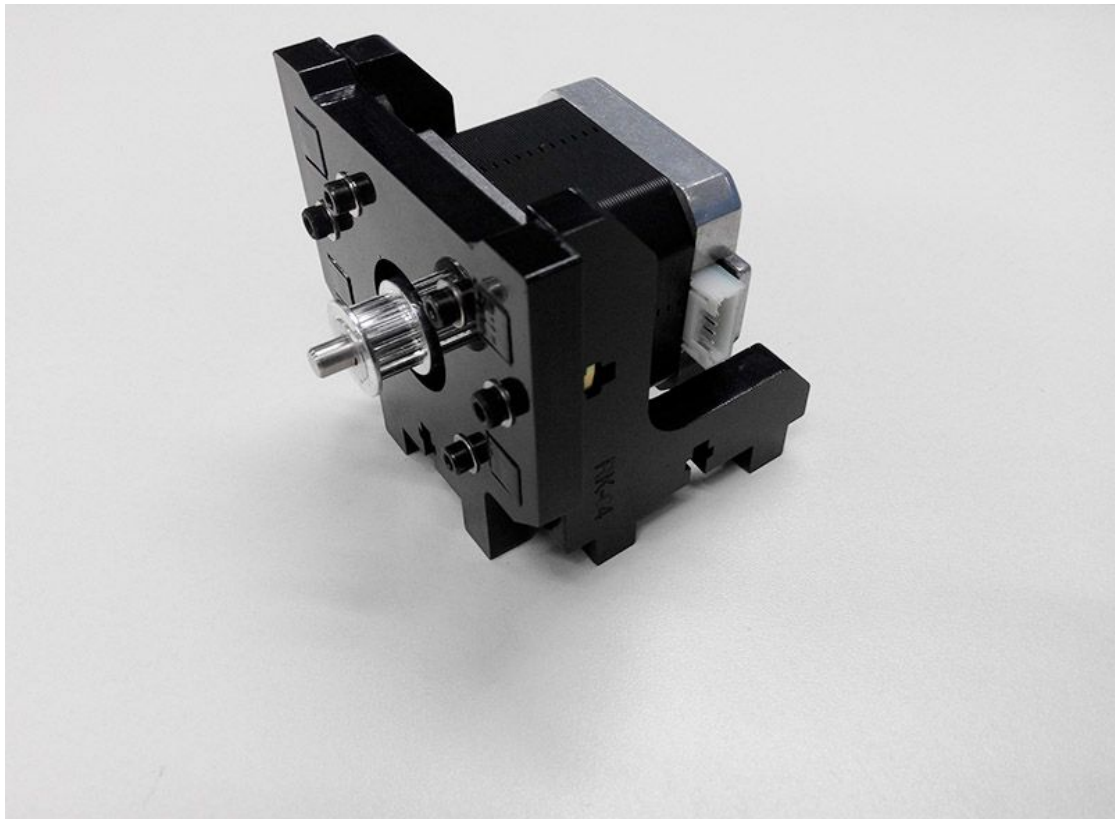

Step3. Mount the motor on A3; screw it up with M3 X 12 screw.

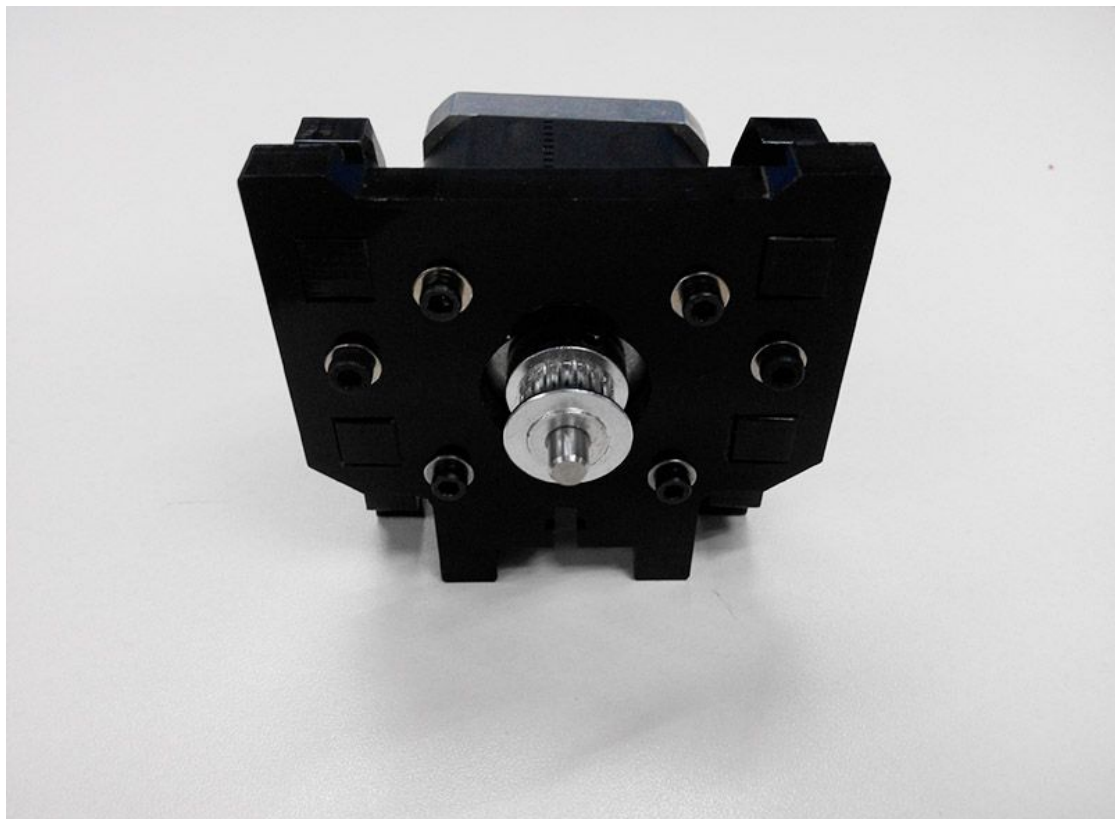



Repeat the steps for the other 2 motor ends

1.2 Connect motor ends to base plate

Name	Part NO.	qty	Pic
base plate	A2	1	
Square nut	14	9	
M3 X 16 Screw	19	9	

M3 washer	5	9	
-----------	---	---	---

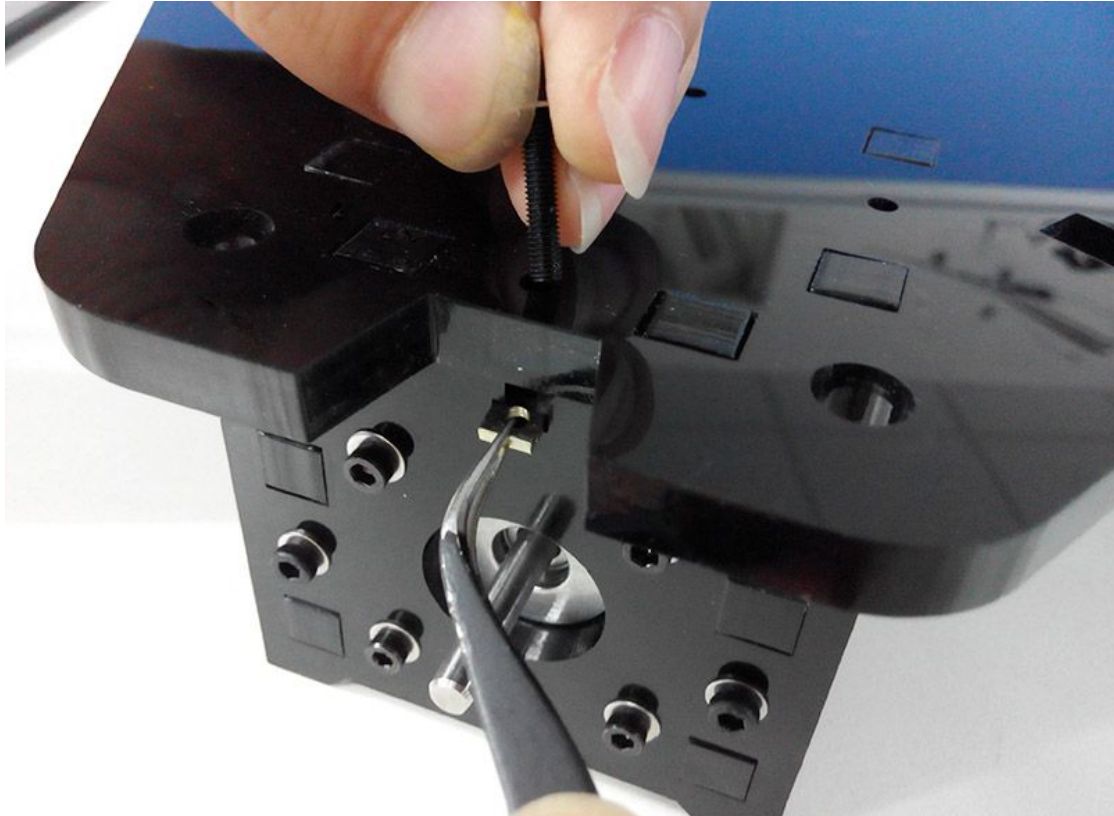

Step1. Mount the 3 assembled motor ends on the base plate (A1); screw it up with M3x16 screws and M3 square nuts.



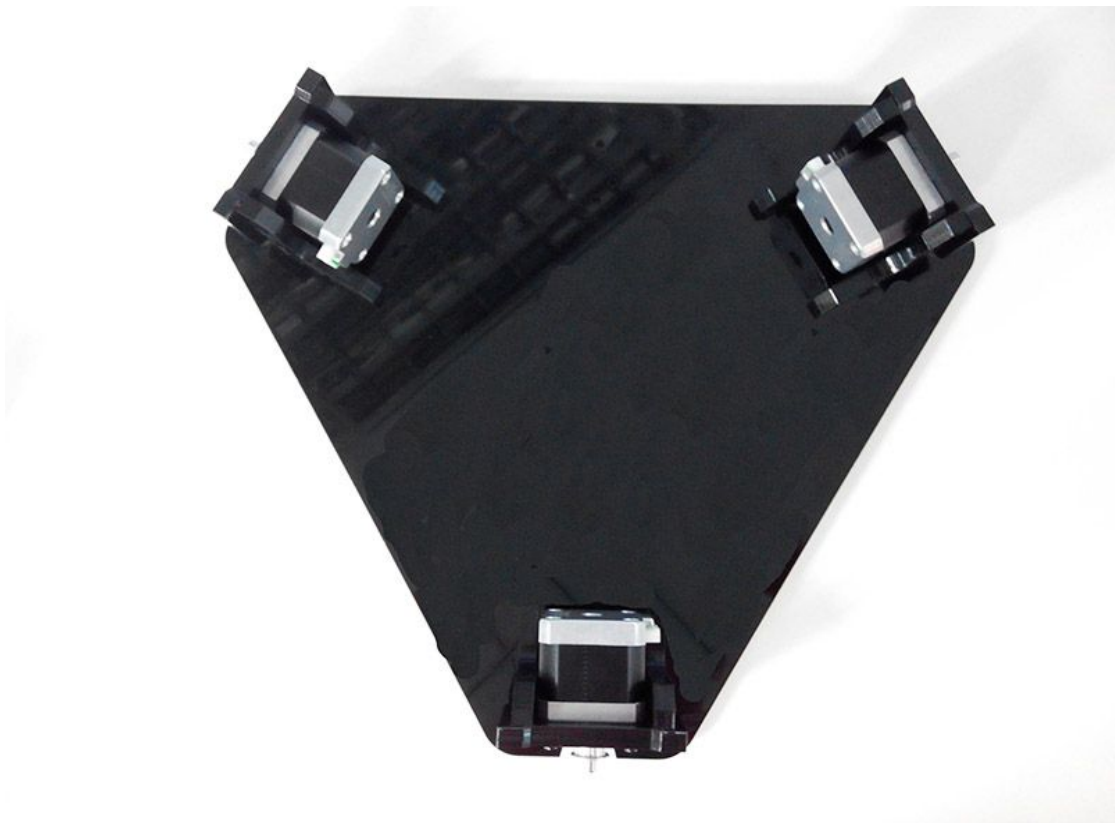





Repeat the step for the other 2 motor ends



1.3 Mount the LCD panel

Name	Part NO.	qty	Pic
LCD frame	A8	1	
LCD support	A9	2	
LCD2004	54	1	

Square nut	14	4	
M3 X 16 Screw	19	4	
M3 X 12 Screw	18	4	
Spacer	34	4	
M3 washer	5	8	
Knob	55	1	

Step1. Assemble the LCD frame and support plate together, screw up with M3 X 16 Screws and M3 square nuts.



Step2. Plug the aircraft- type spacer into the 4 screw hole on the LCD2004.

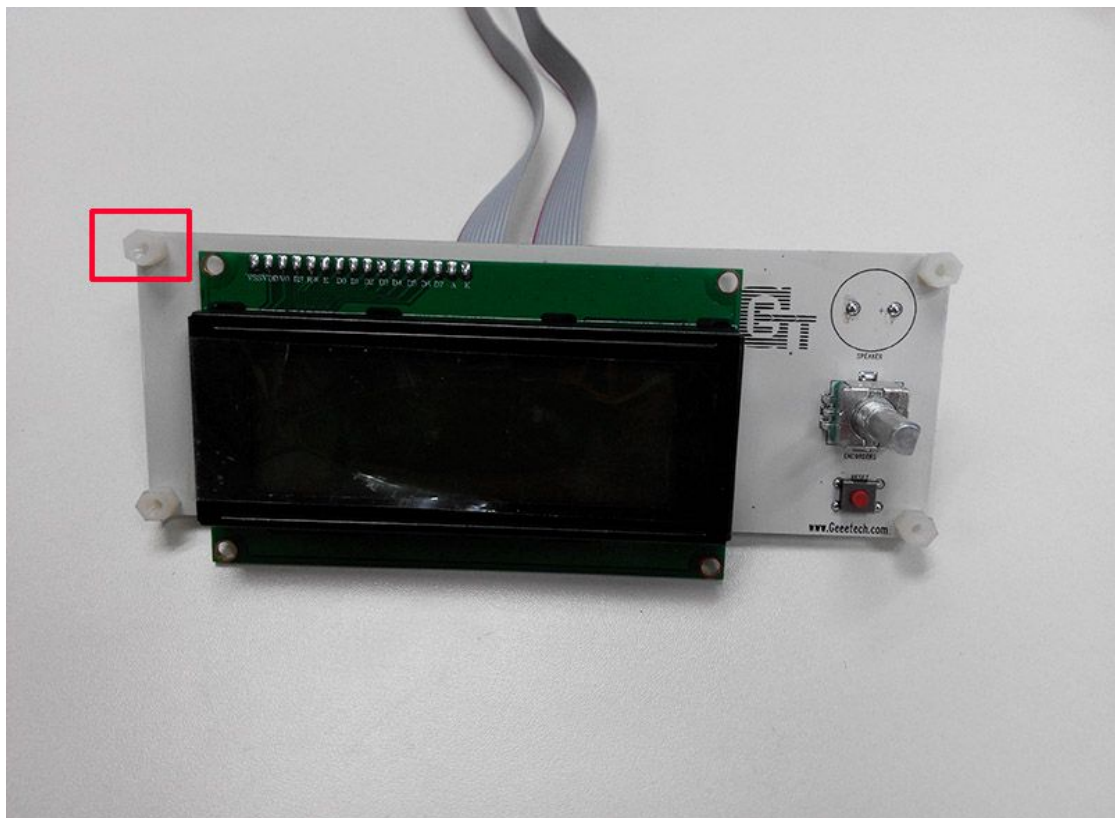

Step3. Screw up the frame and LCD2004 with 4 M3 X 12 Screws.



Step4. Cover the knob and screw it up on the cross section, the screw is in the hole.





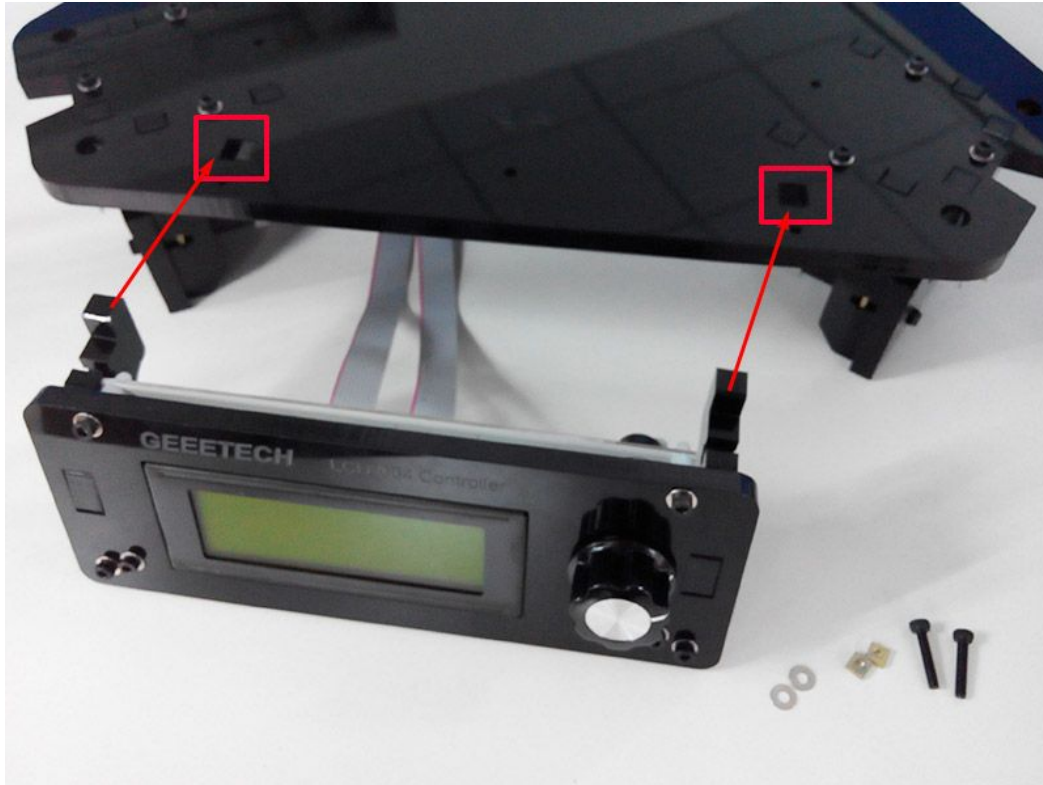



Step5. Mount the assembled LCD kit onto the base plate. Screw it up with 2 M3 X 16 screws and M3 square nuts.





1.4 Mount the fan

Name	Part NO.	Qty	Pic
Fan(40x40x10)	45	1	
M3 X 16 Screw	19	1	
M3 x 25 screw	21	2	
M3 Square nut	14	1	

M3 nut	10	2	
M3 washer	5	3	



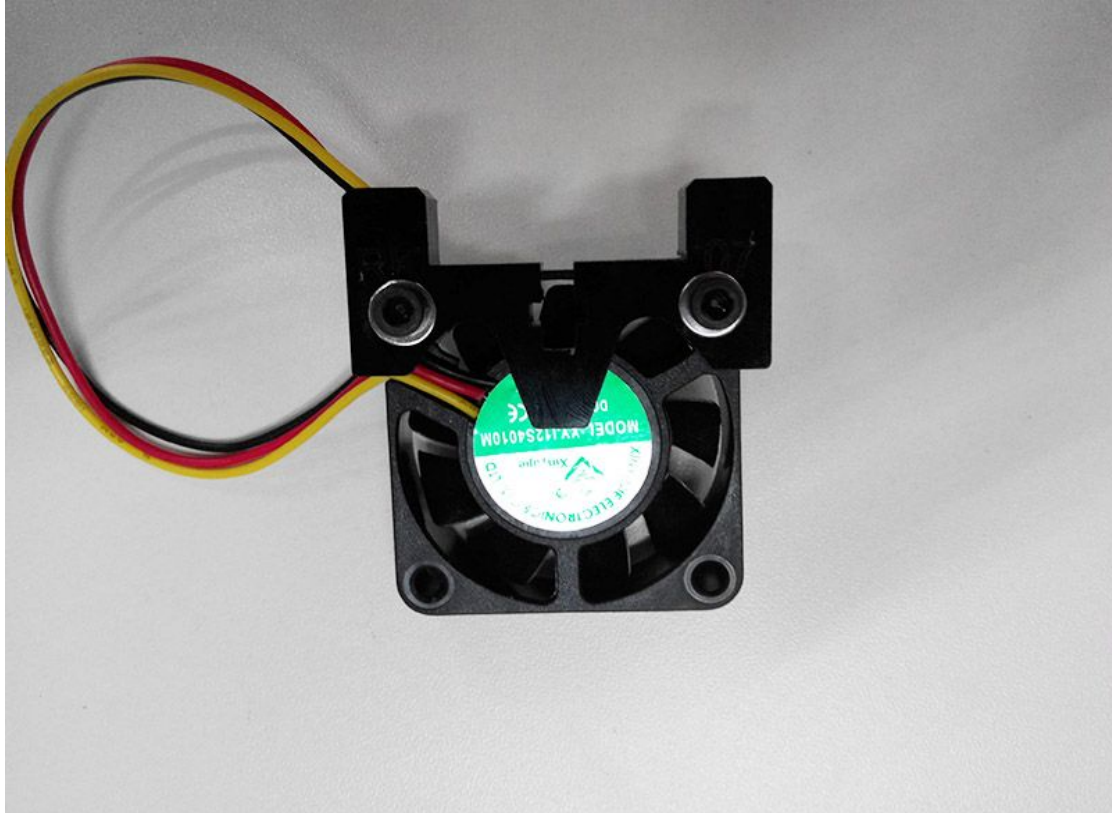

Step1. Mount the fan on the fan mount; screw it up with 2 M3 X 25 screw and M3 nut and washer.

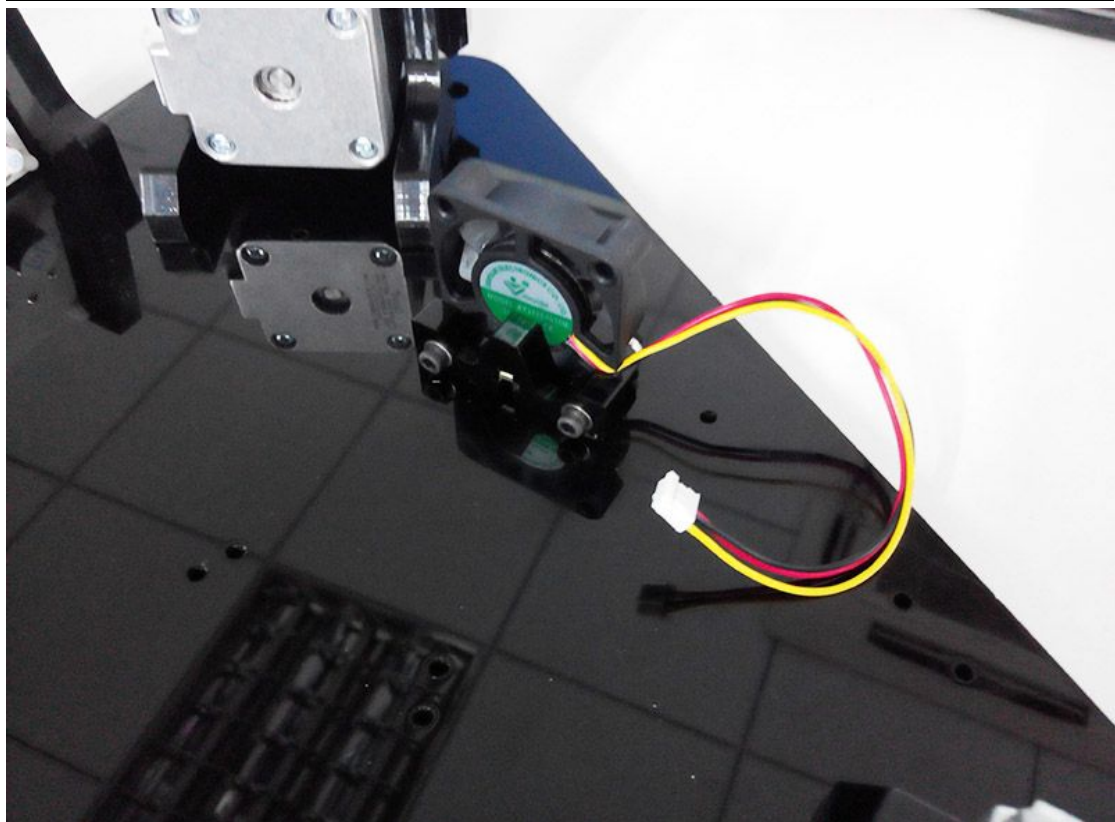

Step2. Mount the assembled fan mount on A2 with a M3 X 16 screw and M3 nut and washer.



1.5 Mount the control board.

Name	Part NO.	Qty	Pic
Control board GT2560	52	1	
Spacer	34	4	
M3 X 12 Screw	18	4	
M3 washer	5	4	



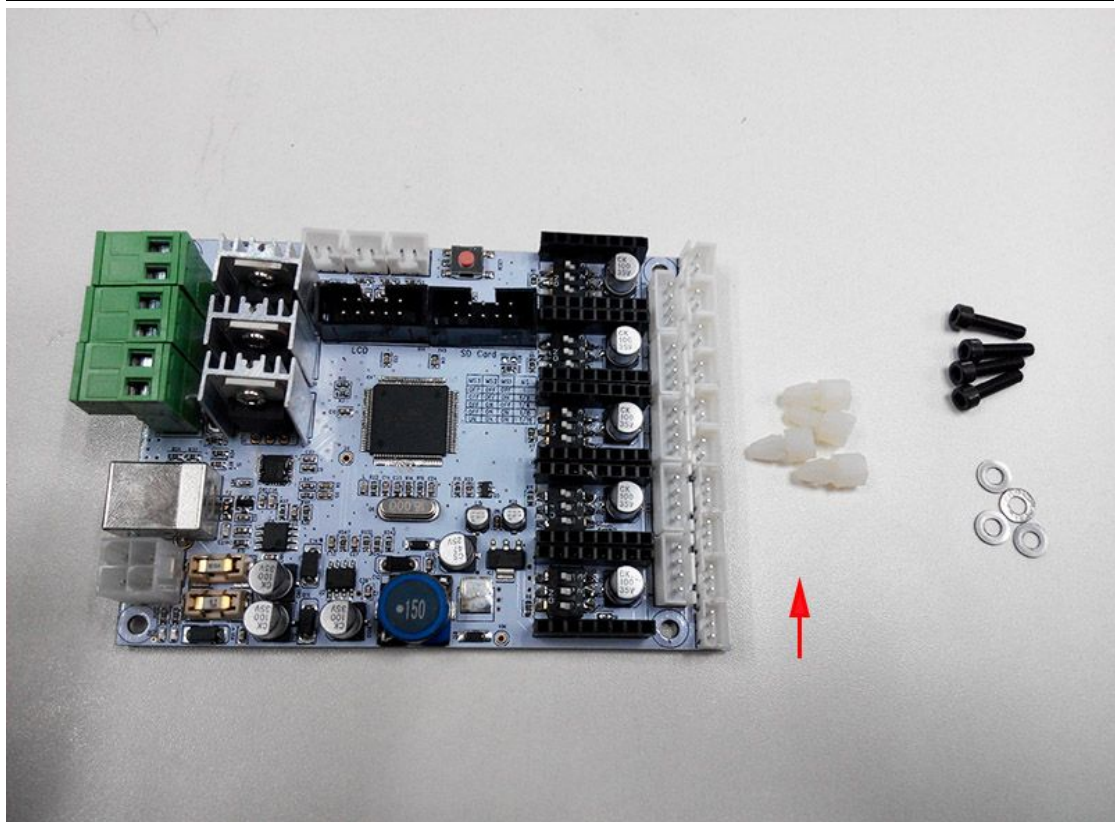

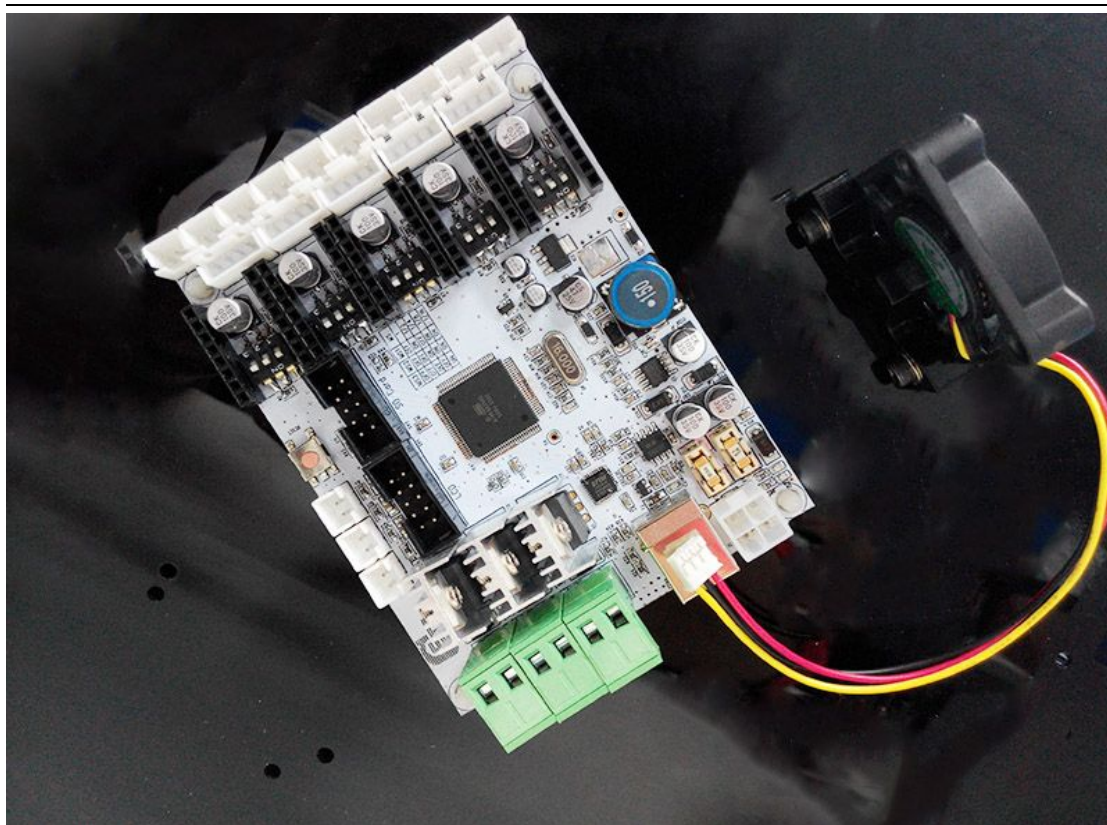

Step1. Plug the aircraft- type spacer into the 4 screw hole on the control board.
The directions of the spacer are as the arrow showing.



Step2. Screw the control board to the base plate (A2) with 4 M3 X 12 Screws and m3 washer.



1.6 Mount the print bed.

Name	Part NO.	Qty	Pic
Building platform	36	1	
Heatbed	44	1	
Hex Counter-sunk-head screw	15	3	
Spring 3.5 x 20mm	27	3	
Wing nut	13	3	
M3 washer	5	6	

*for your convenience, the heatbed for you is pre-soldered, you can mount them directly.

step1. Stack the heatbed and the building platform together.



Step2. Thread the M3X30 screw through the two plates and add washers and spring at this end.



Step3. Lock the other end with a wing nut.

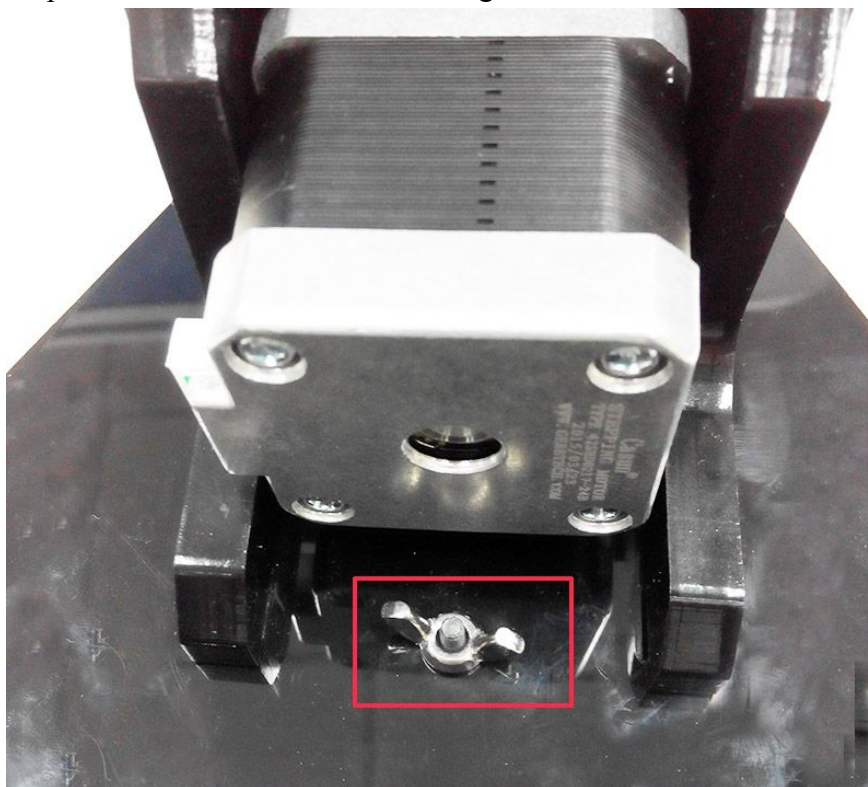



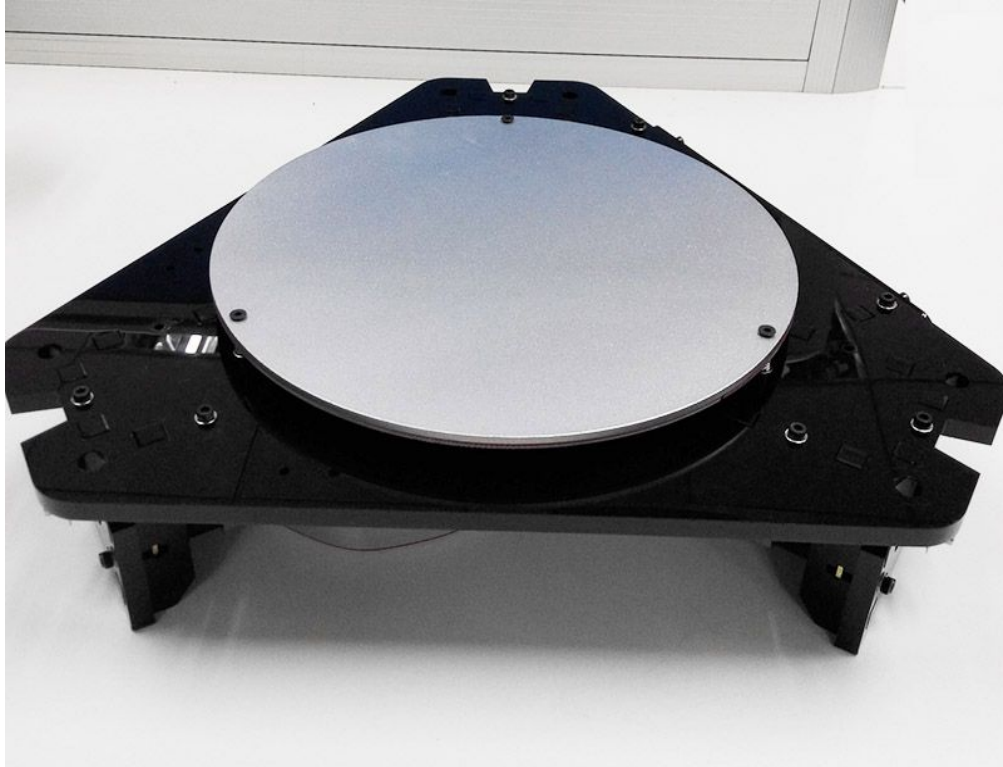



Here is the finished picture.



Chapter 2 Top Plate Assembly

2.1 endstop mount

Name	Part NO.	qty	Pic
Top plate	A1	1	
Endstop mount	A6	3	
Endstop	49	3	
Square nut	14	9	
M3 washer	5	9	
M3 X 16 Screw	19	9	

Step1. Mount the three end stops onto the Endstop mount (A6), screw with M3 X 16 screws.

You may need to use some force to drill the screw into the endstop. The endstop must be fixed tightly.



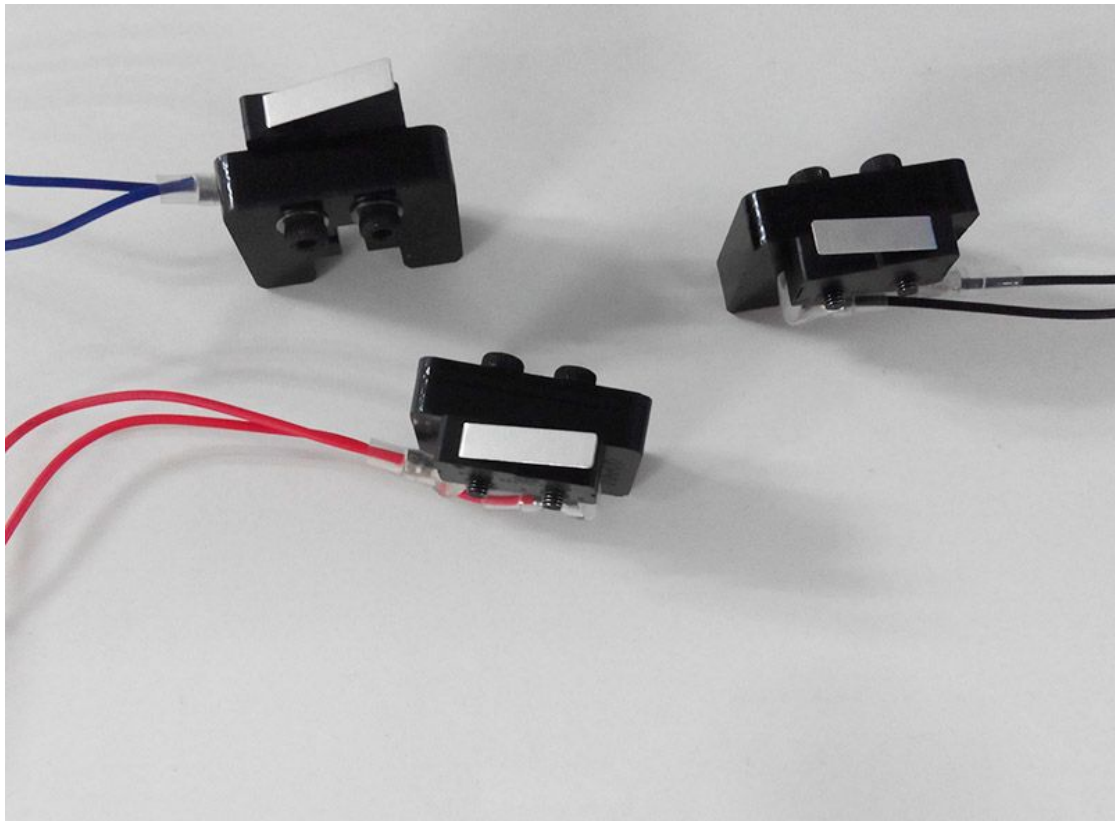



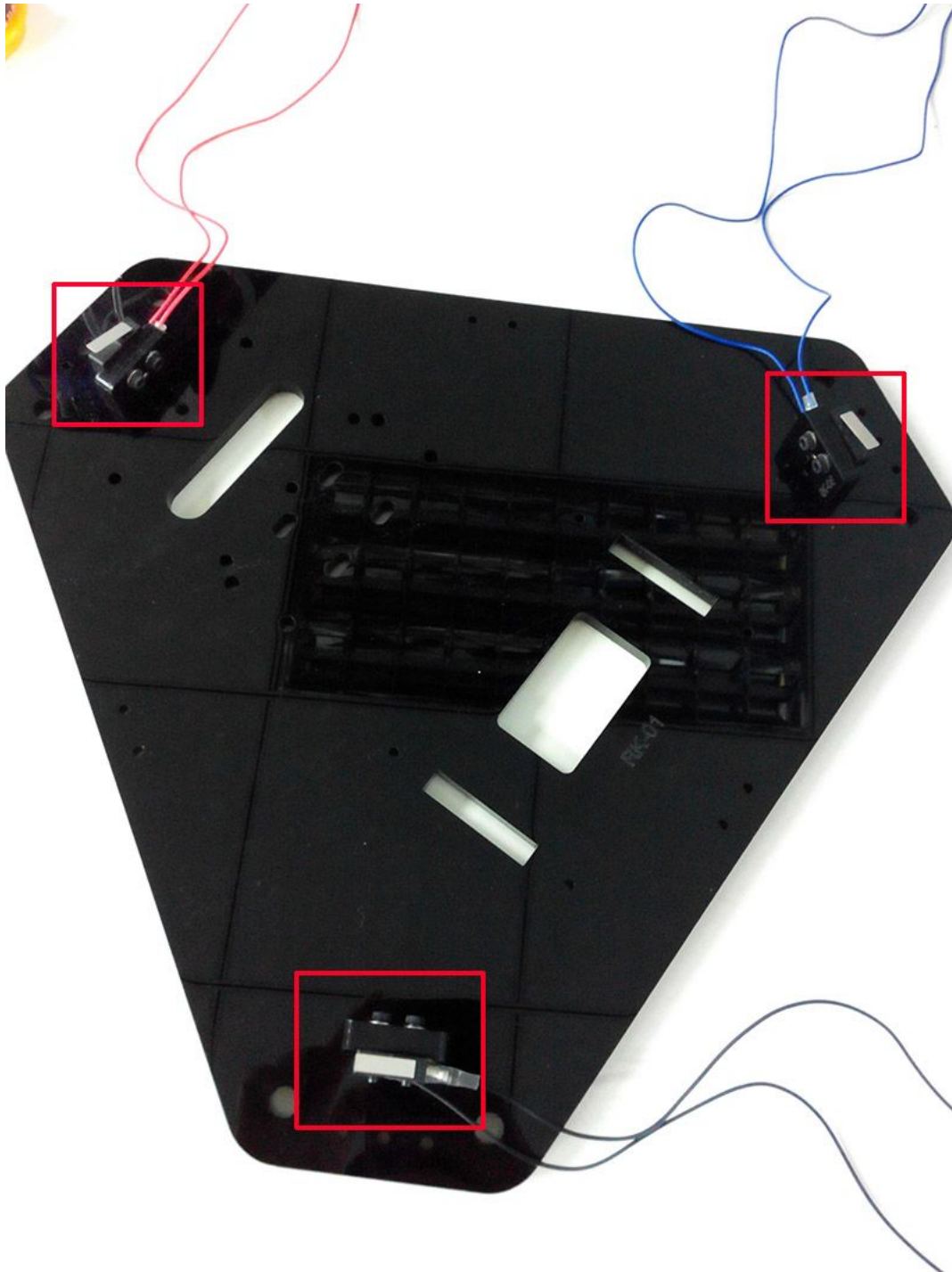



You can press the the endstop on the desk and use the M3 screw to drill the hole to make is a bit looser. Then, you can attach it on the endstop mount easily.



Step2. Mount the assembled parts onto the top plate. Screw up with M3 x 16 screws and M3 square nuts. Note the directions of the endstop.



2.2 Drive wheel mount

Name	Part NO.	qty	Pic
Drive wheel mount	A5	3	
Driven wheel holder	32	3	
624zz ball bearing	29	6	
M3 X16 Screw	19	3	
M3 X25 Screw	21	6	
M4 X 25 Screw	25	3	
M3 nut	10	6	
M4 lock nut	12	3	
Wing nut	13	3	
M3 washer	5	15	

Step1. Mount the Drive wheel mount on A1; screw them up with M3 X25 screws, M3 nut and washers.

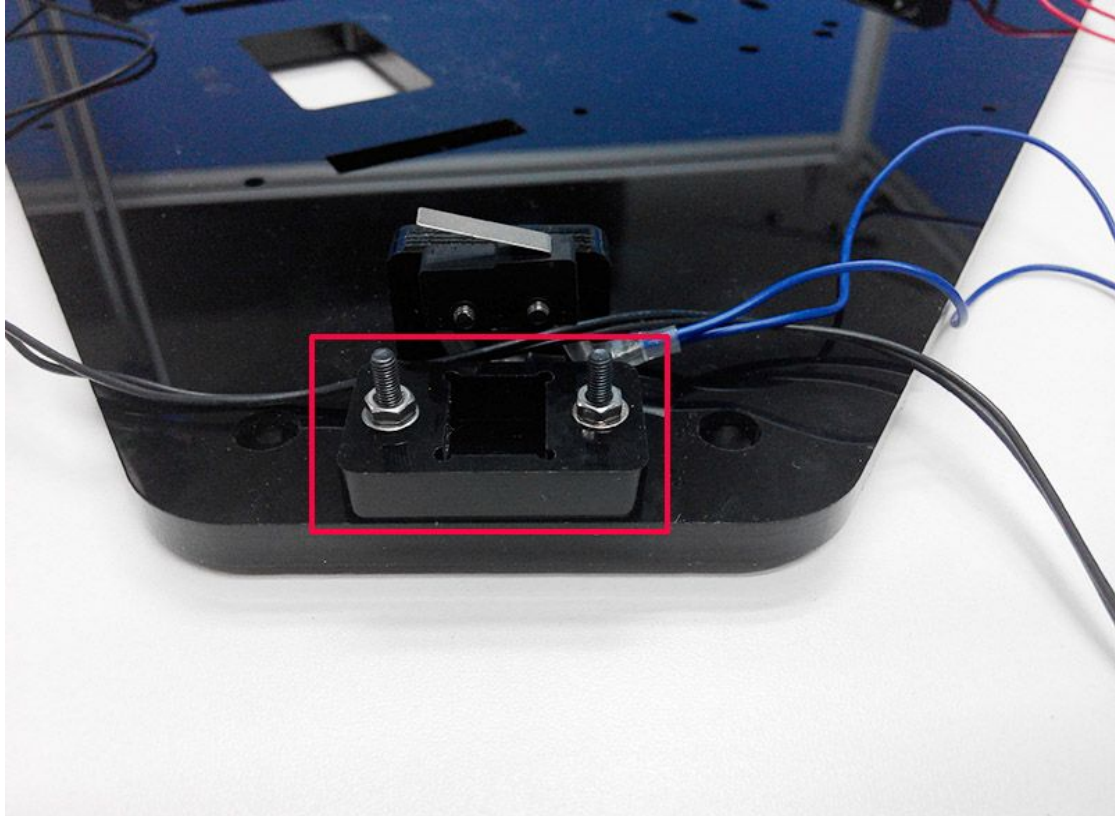

Step2. Thread the M3 x 16 screw through the driven wheel holder.



Step3. Put the M4 x25 screw through the holes with the two 624ZZ bearings in between. Lock the other end with a M4 lock nut. You may need a spanner to tighten locking nut.



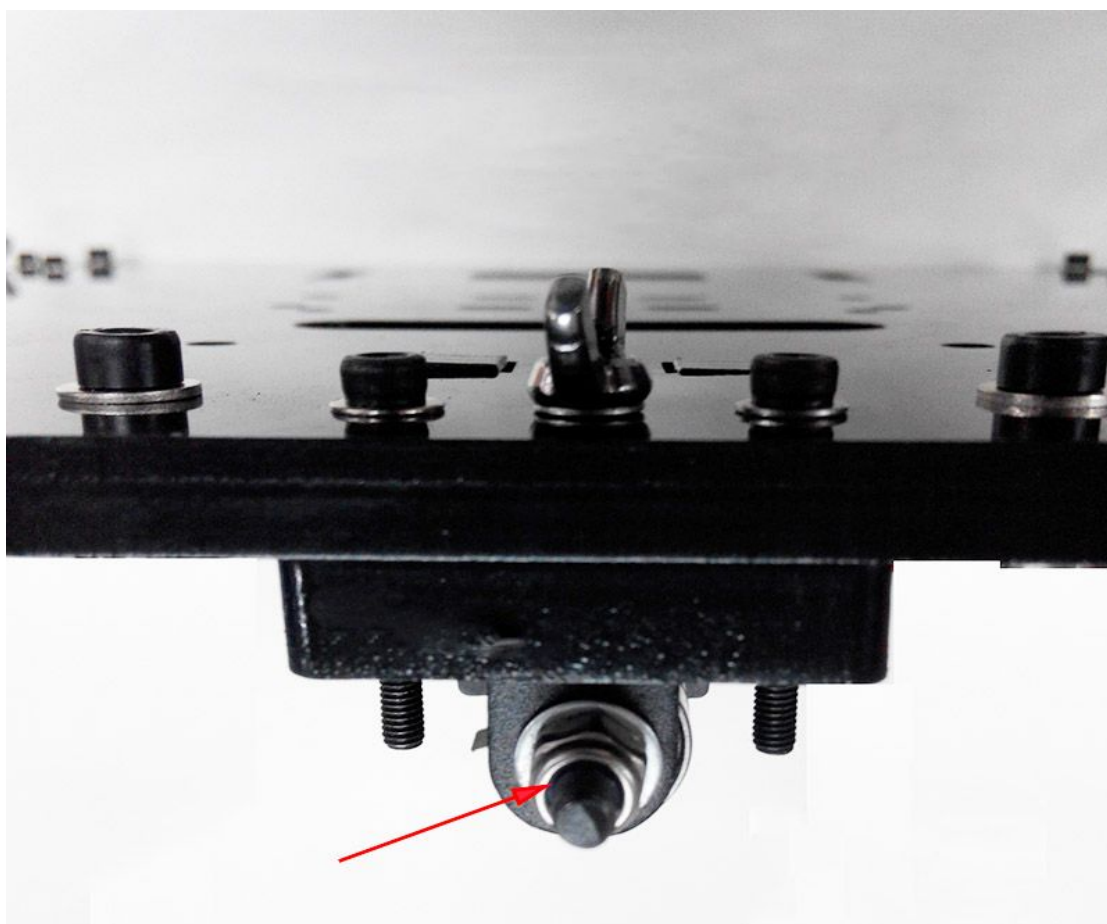

Step4. Mount the assembled driven wheel holder onto the top plate. And screw it with a wing nut. Pay attention to the direction of the driven wheel.



Repeat the above 4 steps for the other 2 driven wheels.

2.3 Mount the extruder

Name	Part NO.	Qty	Pic
Extruder	50	1	
M5 x 16 screw	26	4	

Find out the locating holes on the top plate; screw up the extruder with 4 M5 x 16

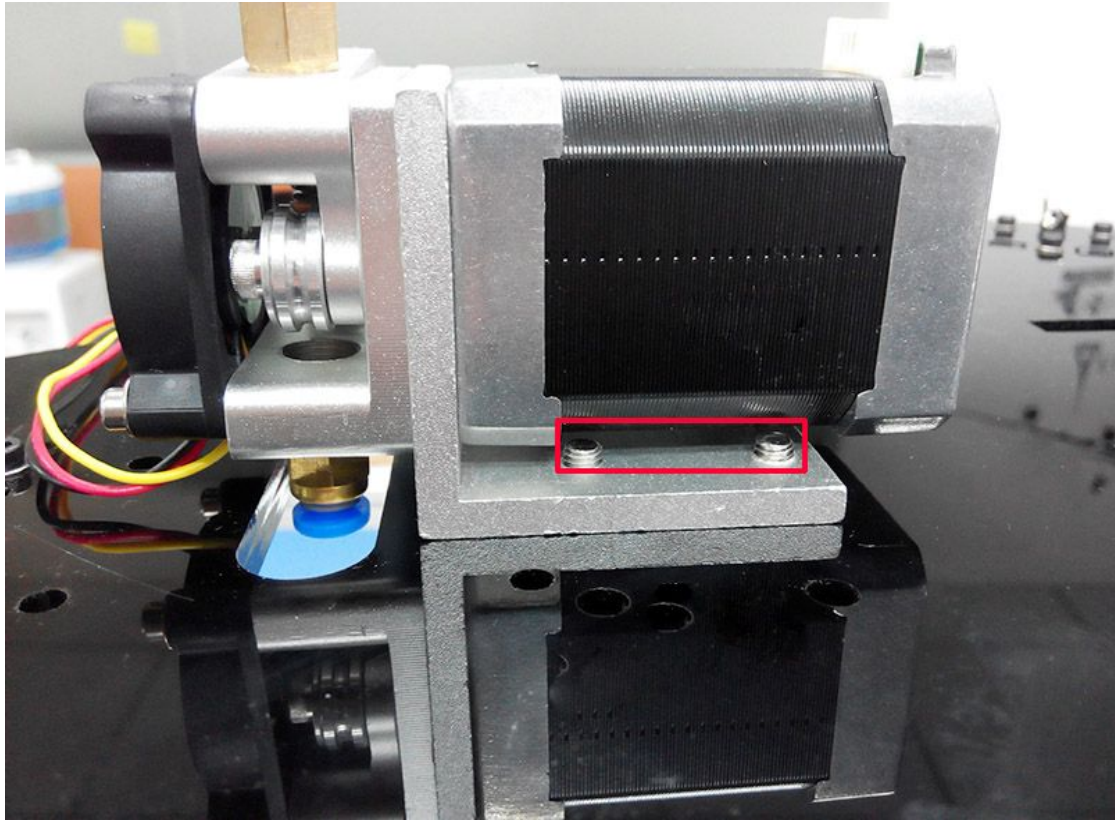

screws and washers.

The screws are bottom - up.



Note: If your are assembly the G2s, you will need 8 Mher5 x 16 screws and 4 washers to mount another extruder.

2.4 Mount the spool holder

Name	Part NO.	Qty	Pic
Spool holder Side panel	A10	1	
Spool holder Side panel	A11	1	
M3X16 screw	19	4	

Square nut	14	4	
------------	----	---	---



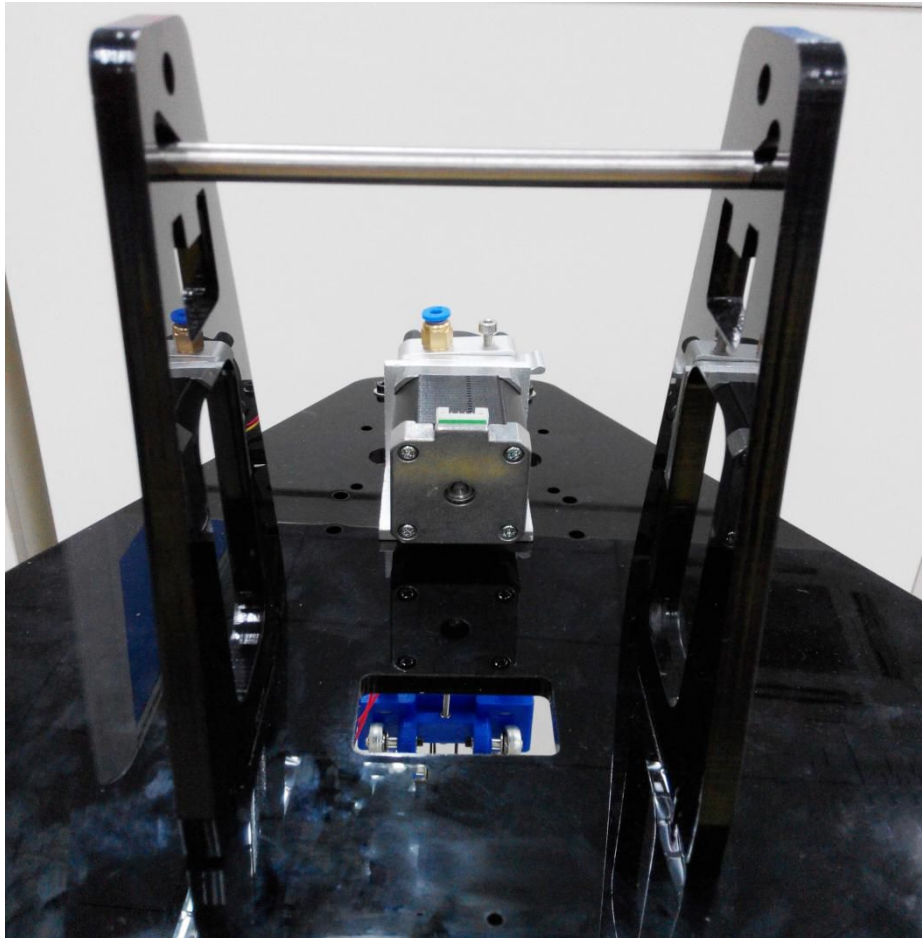

Screw up the spool holder panel on the top plate separately with M3X16 screw and M3 nut and washer.



Through the spool holder rod into the panel, or you can do it later after you finish the building.

Chapter3 mount the smooth rods

Name	Part NO.	qty	Pic
Smooth Rod	1	6	

Linear Bearing	30	6	
M4 X12 Screw	23	12	
M8 Washers	9	12	
M4 washer	6	12	

Step1. Insert the smooth rods into the slot on the base plate; put a M8 washer on the end of the rod.

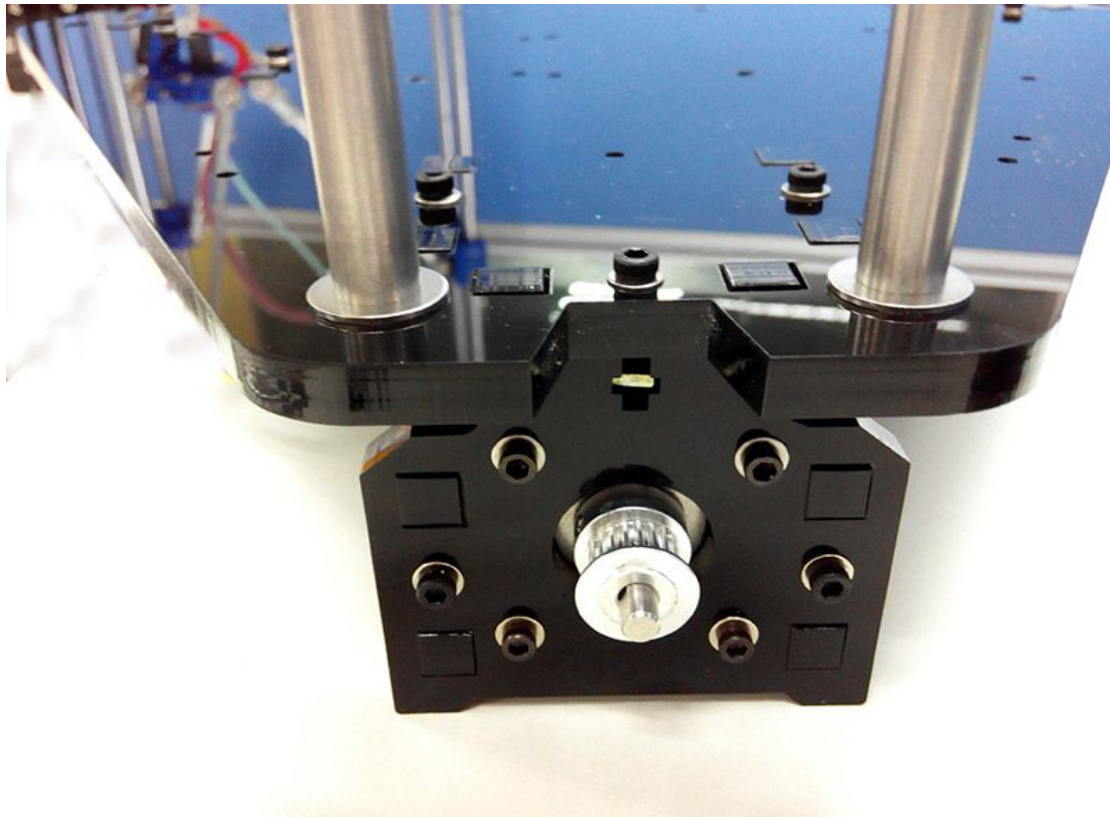

Step2. Screw up the rods with M4x 25 screws and M4 nuts.

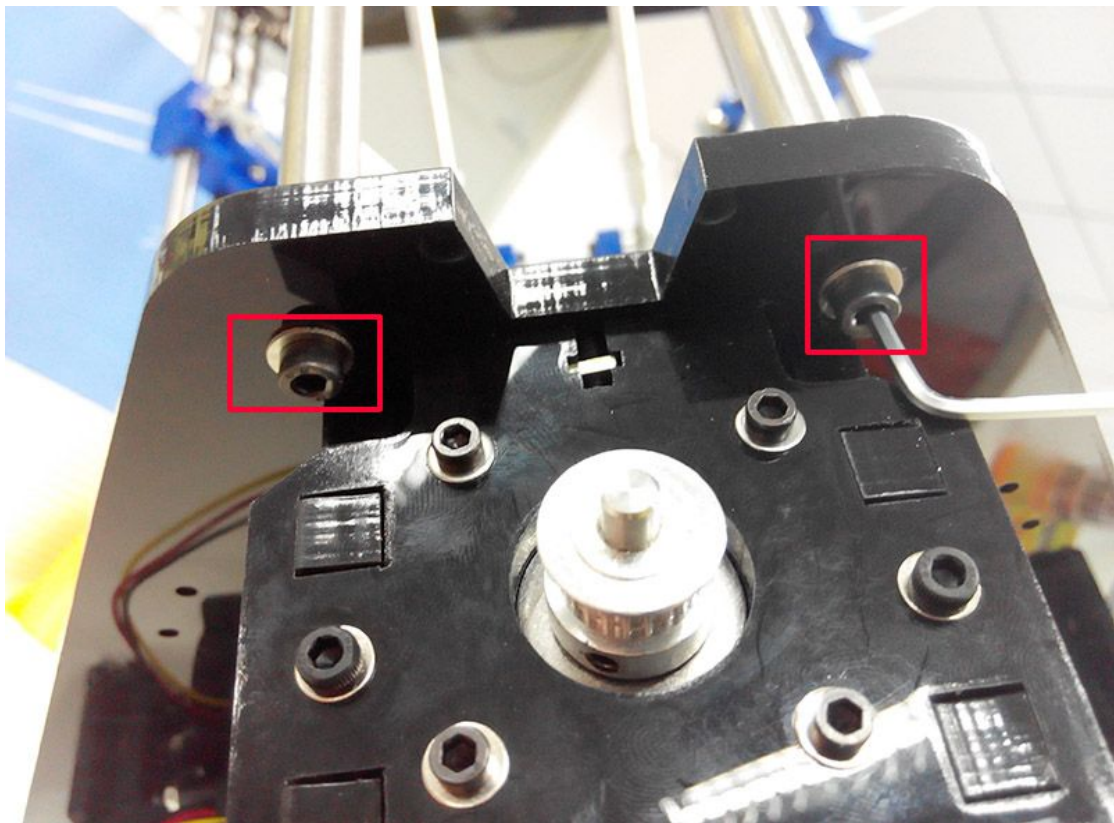

Repeat the above two steps for other rods.



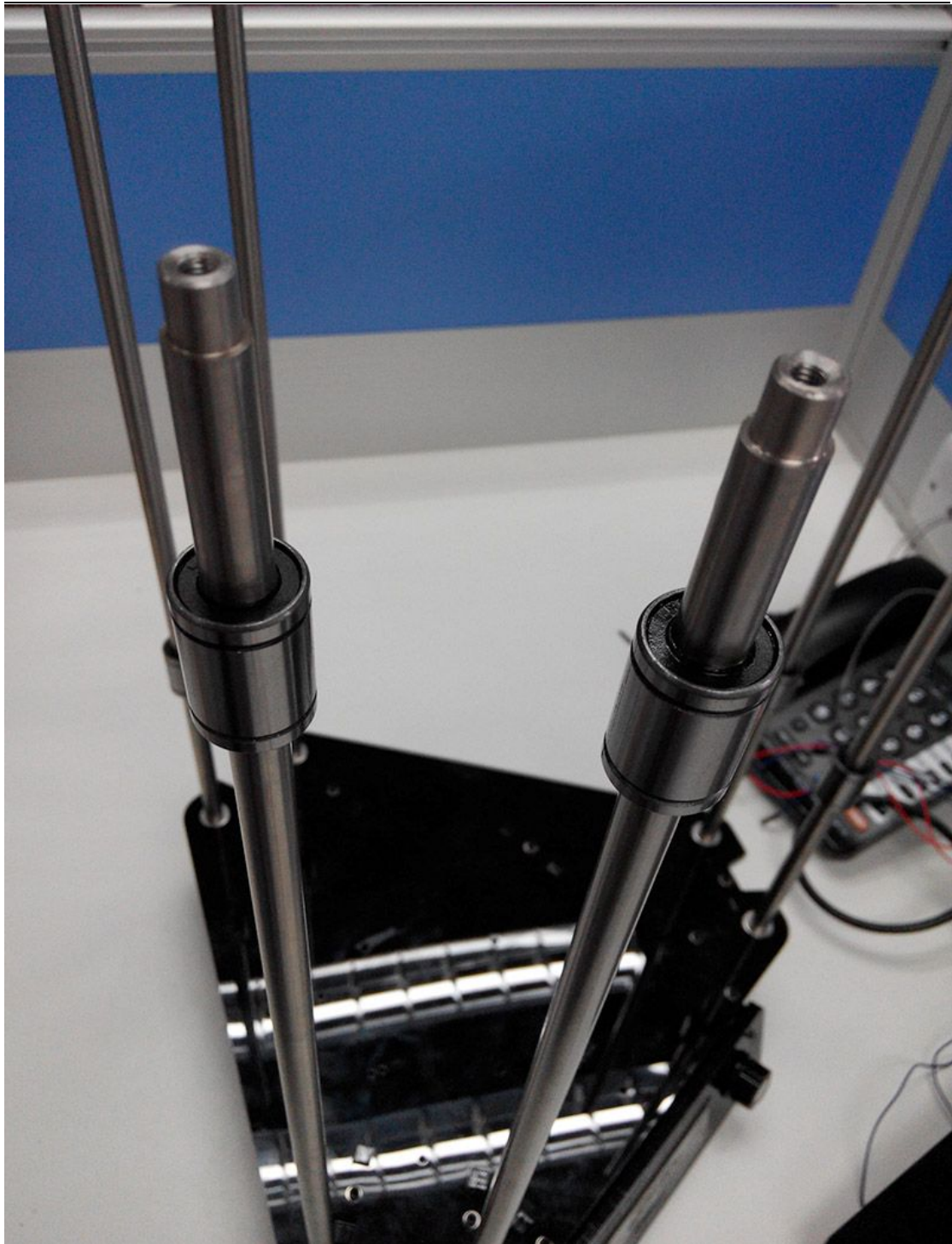





Step3. Slide the 6 linear bearings into the 6 smooth rods separately.





















Step4. Put a M8 washer on each top end of the rods and cover the top plate on the rods, screw them up with M4x 25 screws and M4 nuts.



Chapter 4 Assemble the print platform

Name	Part NO.	Qty	Pic
Diagonal Rod	1	6	
rod-end bearing holder	3	6	
Fan (30x30x10)	46	1	
Hotend	51	1	
Endstop	41	1	
Spider	P1	1	
Hotend bracket	P2	1	
Hotend half bracket	P3	1	

Fan mount	P5	1	
Carriage	P4	3	
Prob	57	1	
Zip tie	35	12	
Round head screw with pad	16	12	
M3 x 8 screw	17	12	
M3 x 12 screw	18	2	
M3 x 16 screw	19	6	
M3 x20 screw	20	3	
M3 x40 screw	22	3	
M4 x 16 screw	24	2	
3.5*30 spring	28	4	
M3 nut	10	7	

M4 nut	11	2	
M3 washer	5	20	
M4 washer	6	2	
M6 washer	8	12	
Printed lock ring	P6	1	

4.1 Assemble the spider

Step1. Insert the hotend into the half bracket, stack the hotend bracket and half bracket together, screw up with 4 M3 x 16 screws and M3 nut.

(Note: For your convenience, the hotend is assembled with heaters and sensors, so, please ignore the difference in the picture)

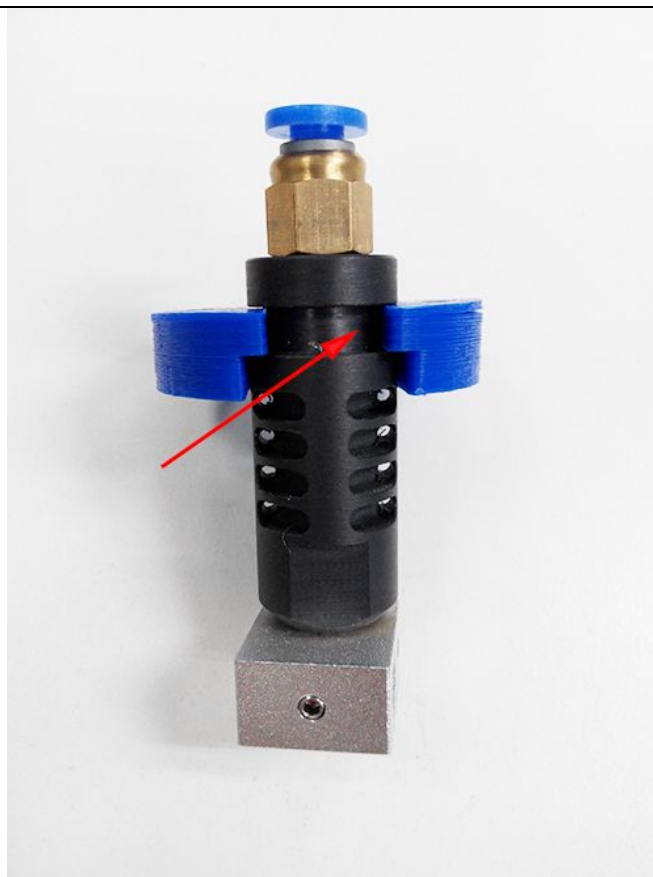

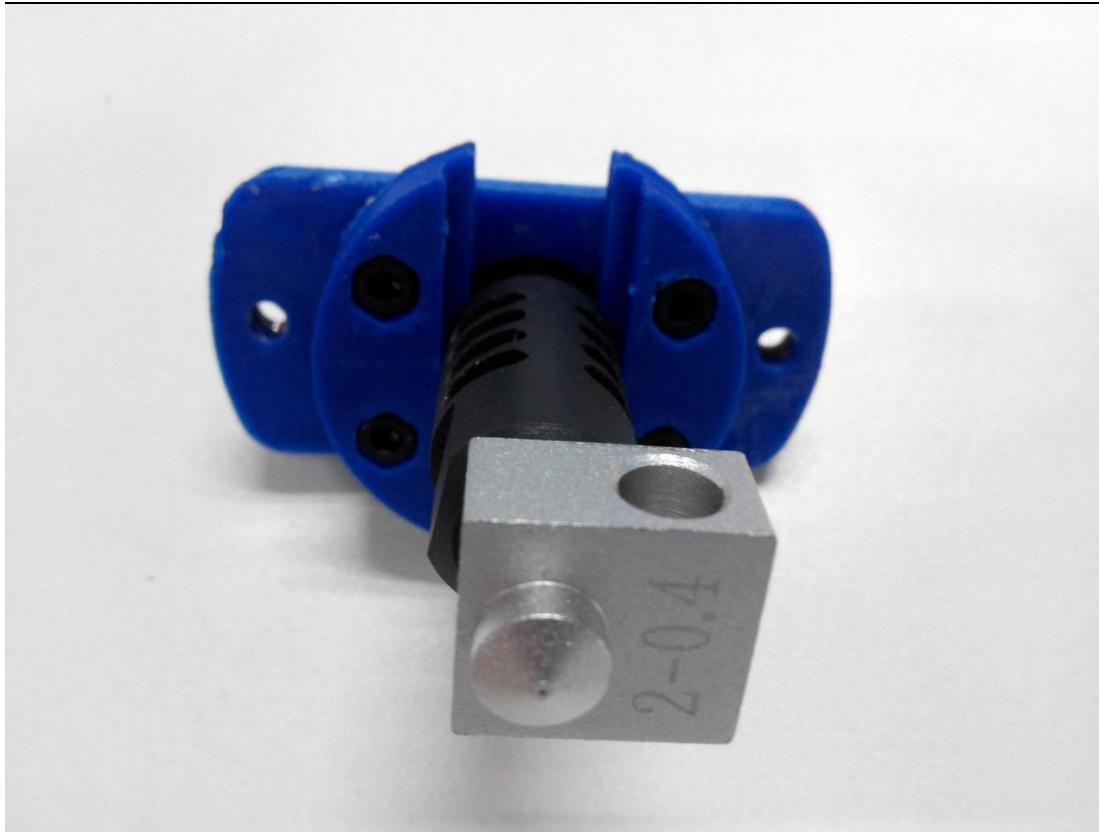

If you are building G2s, the steps are the same.



Step2. Screw the fan onto the fan mount with 2 M3x 20 screws.

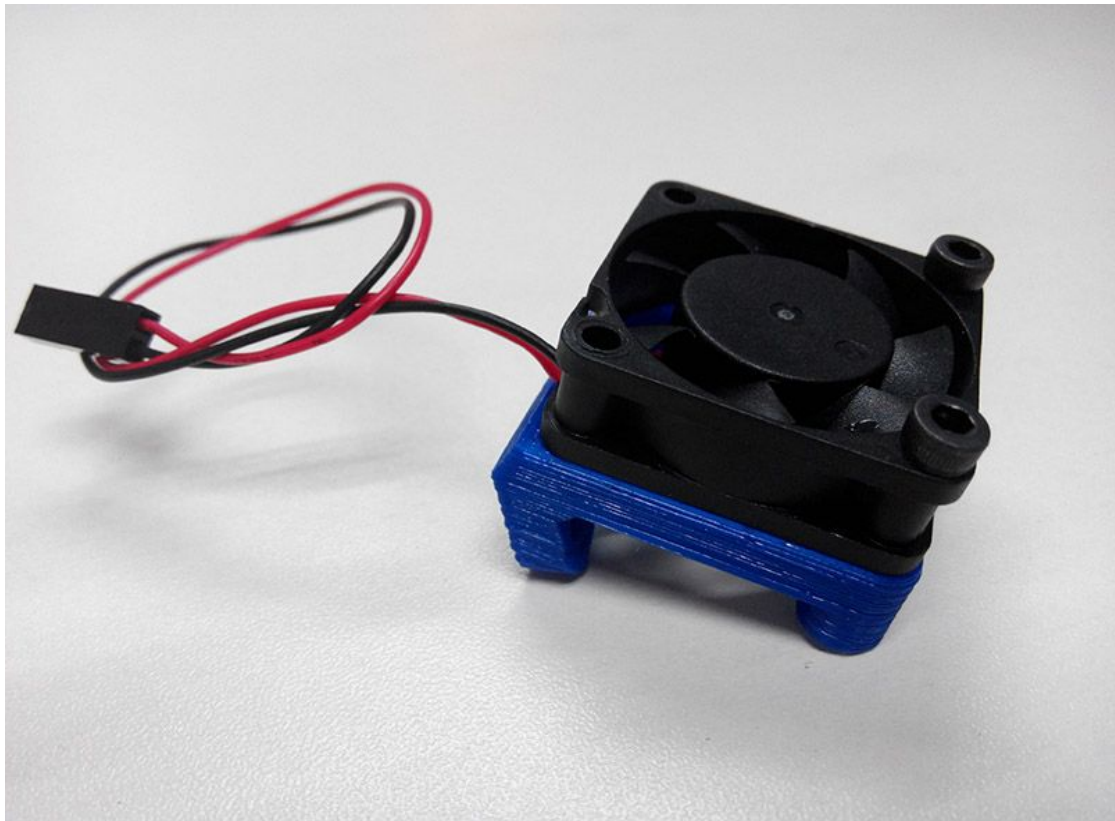

Step2. Mount the assembled fan and hotend onto the spider, using the following screws and nuts as shown in the picture.

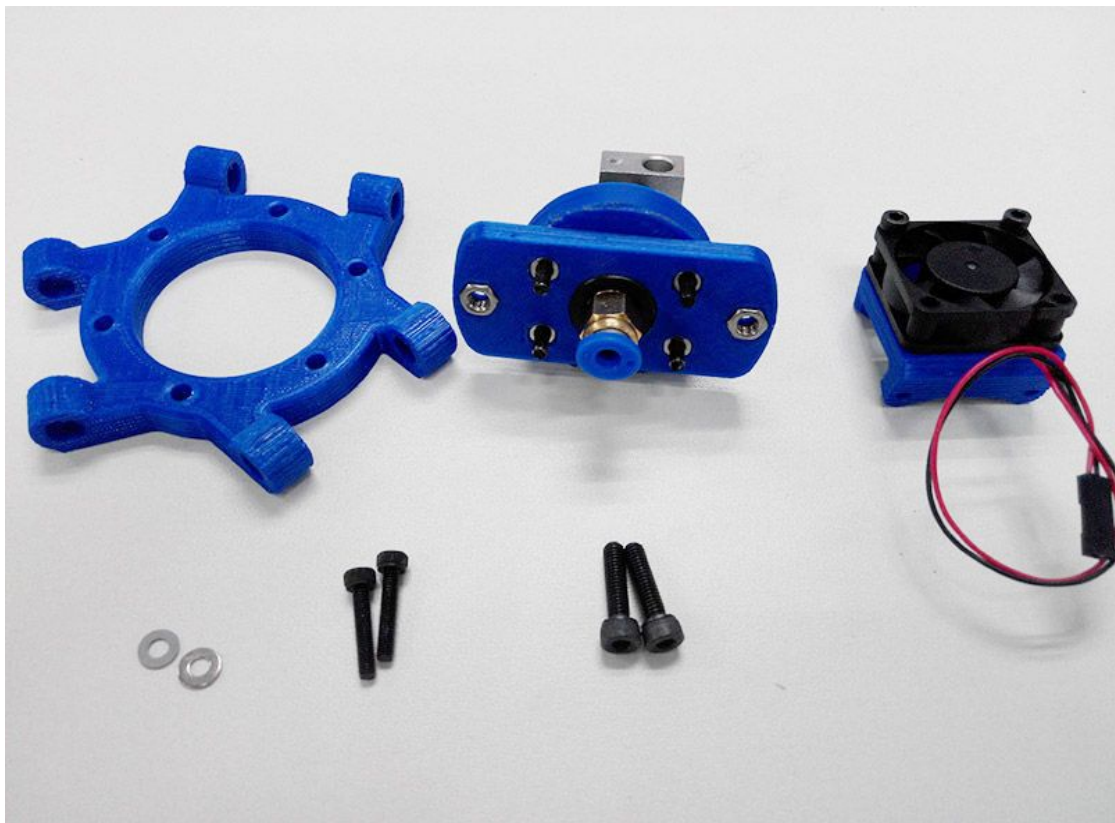

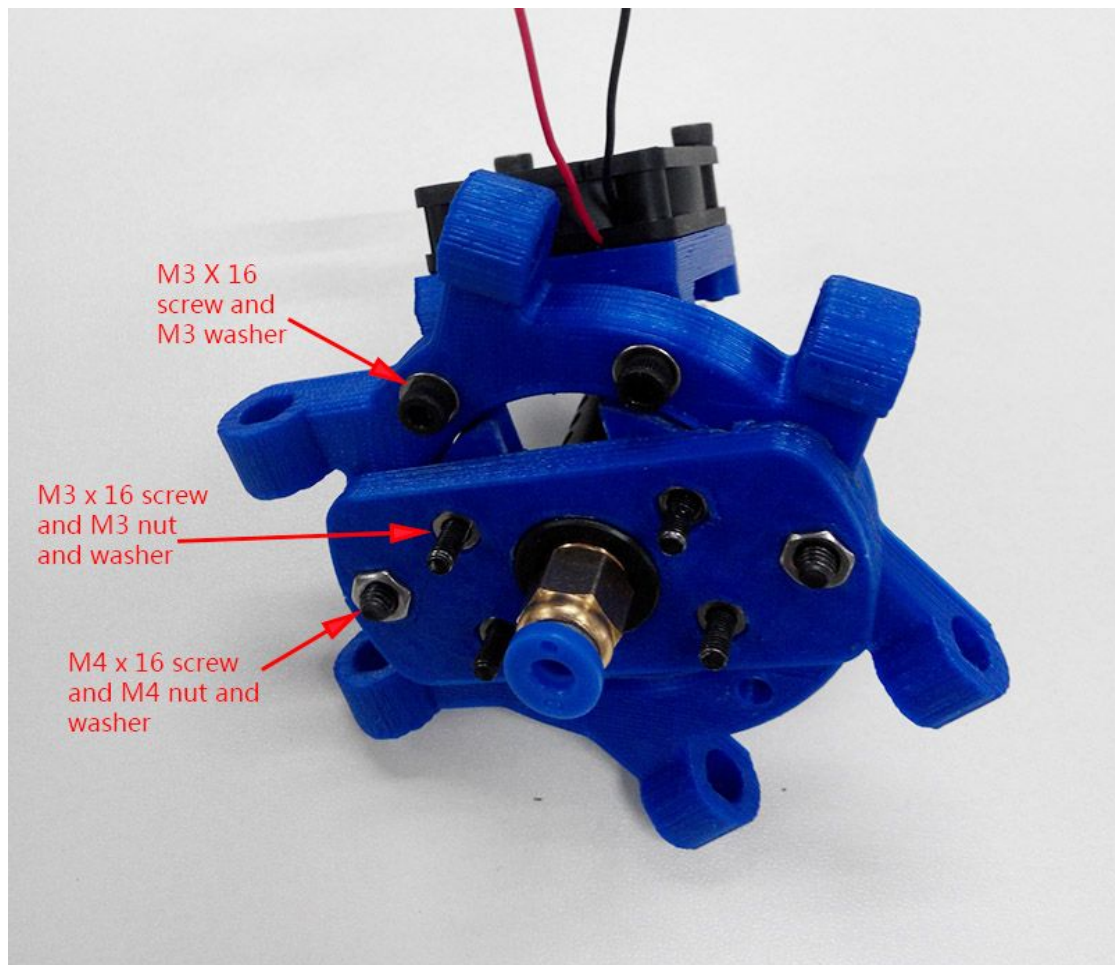

4.2 Assemble the auto-leveling probe

Note please: as the auto-leveling probe was added to Rostock miniG2 after we finished the design, so this picture is taken after we finished the whole building, but we suggest you assemble the auto-leveling probe at this step.

Step1. Mount the endstop onto the spider with 2 M3x 12 screws.

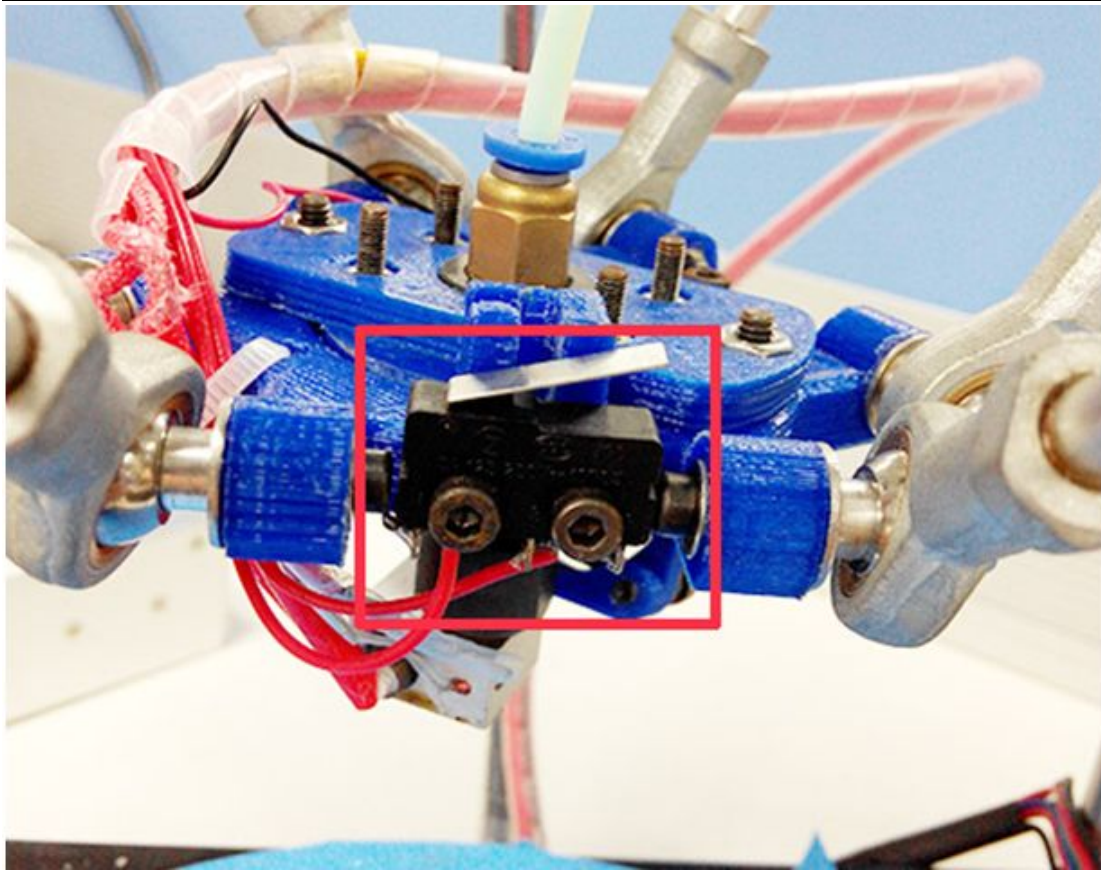

Step2. Thread the probe into the hole.

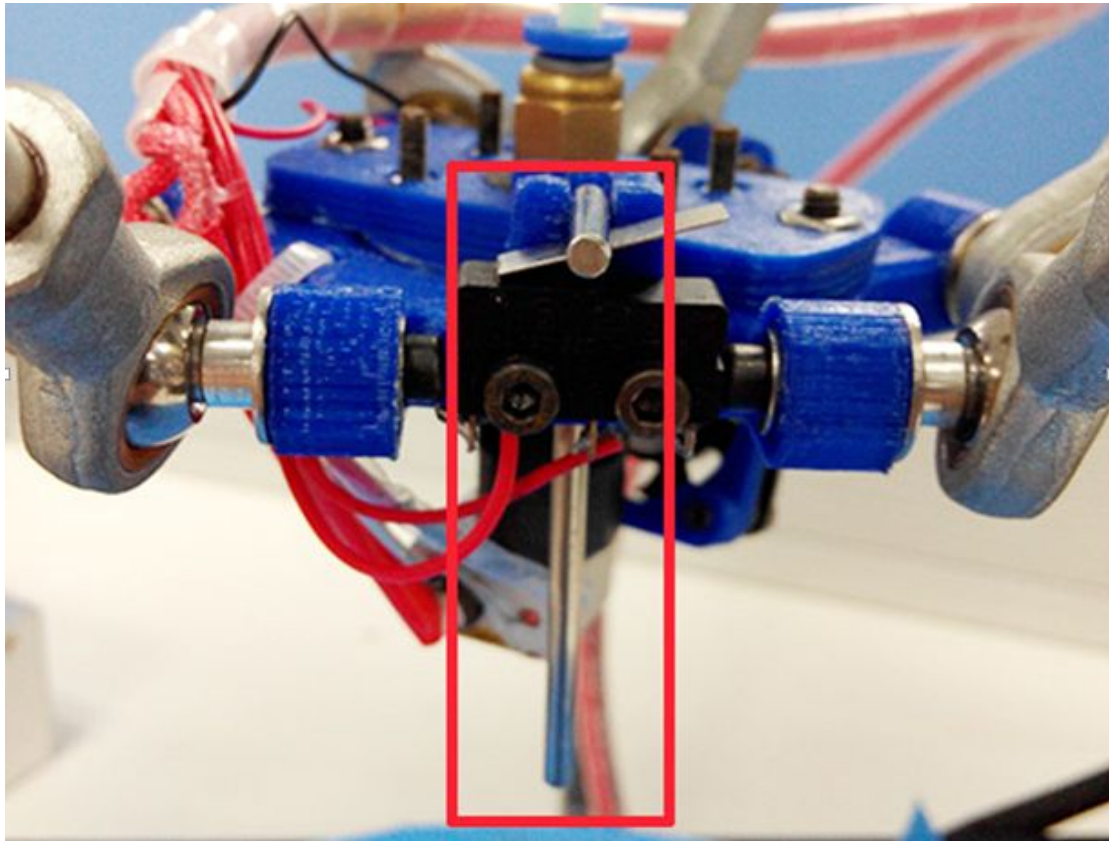

Step3. Thread the spring and the lock ring around the prob and screw up the M3 screw in the ring.

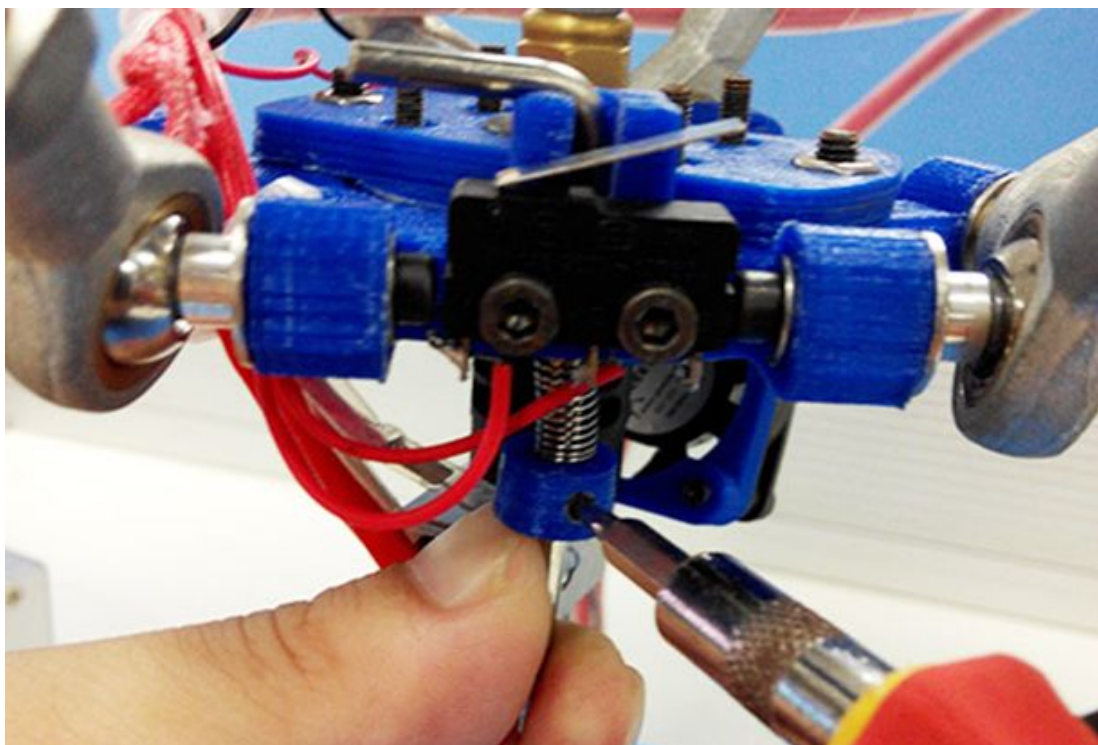
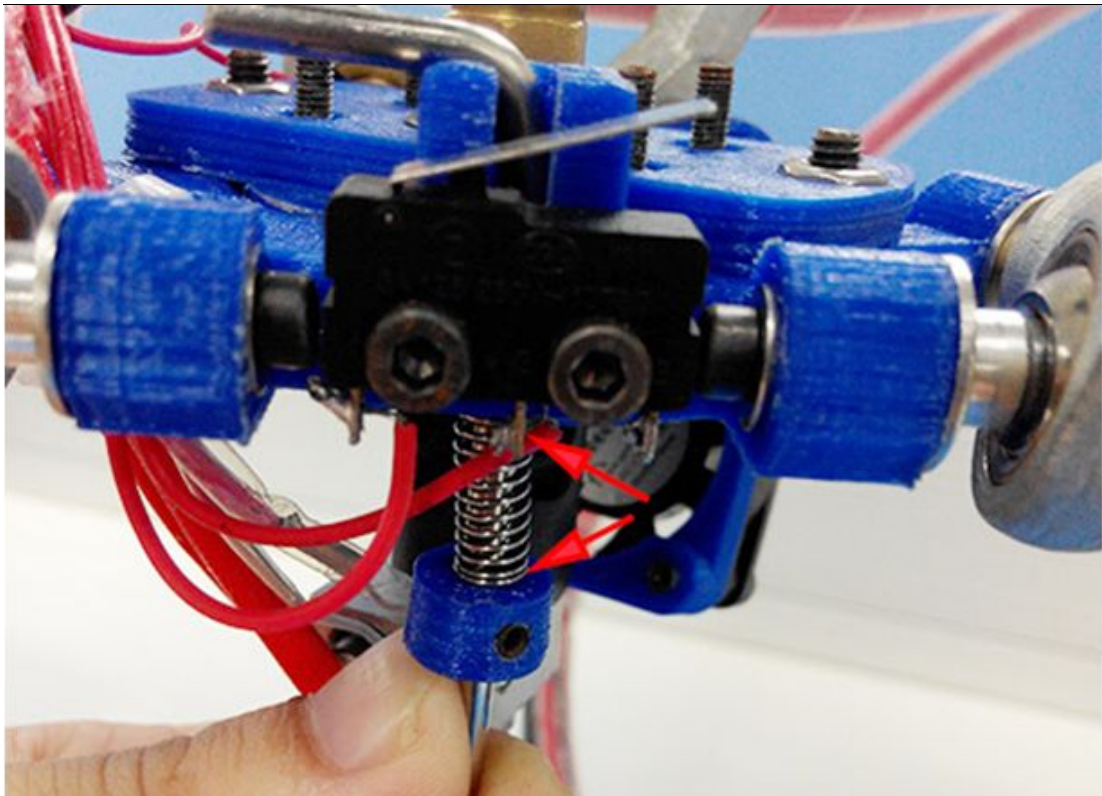

4.3 Assemble the diagonal rods.

Step1. Mount the diagonal rod onto the carriage.

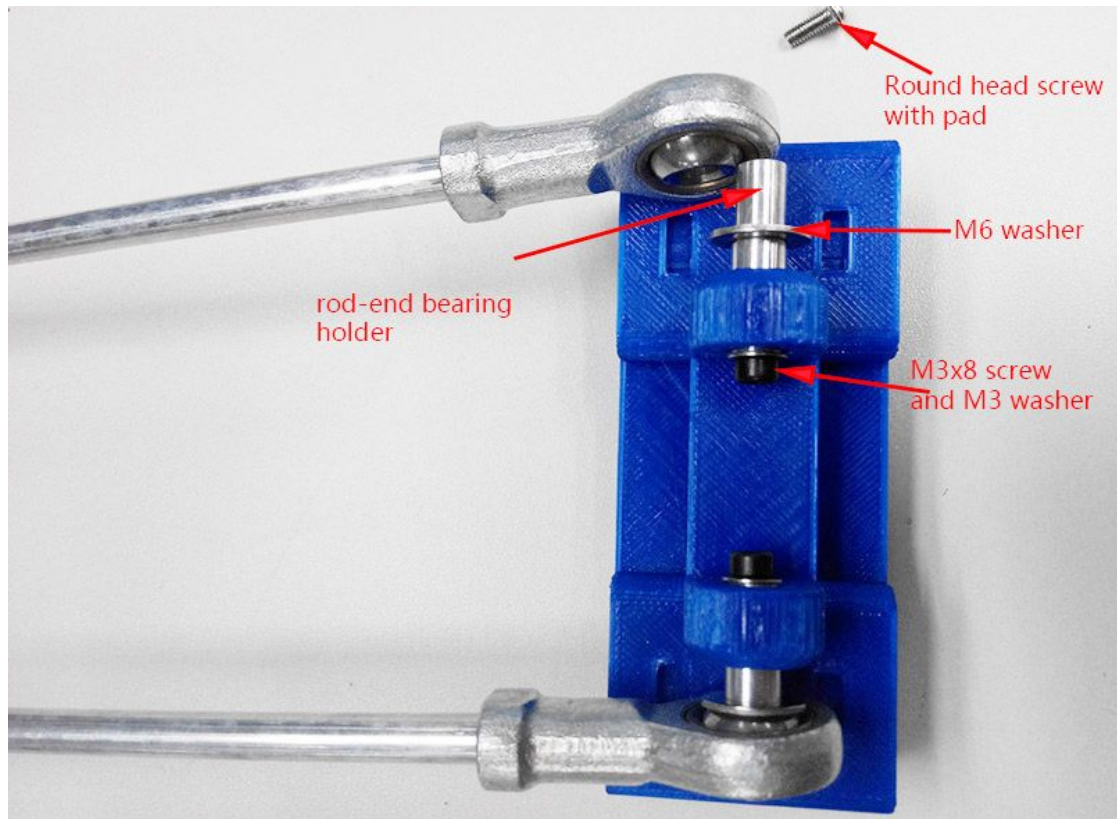

washer here is very important, do remember! You can even use M4 washer here.

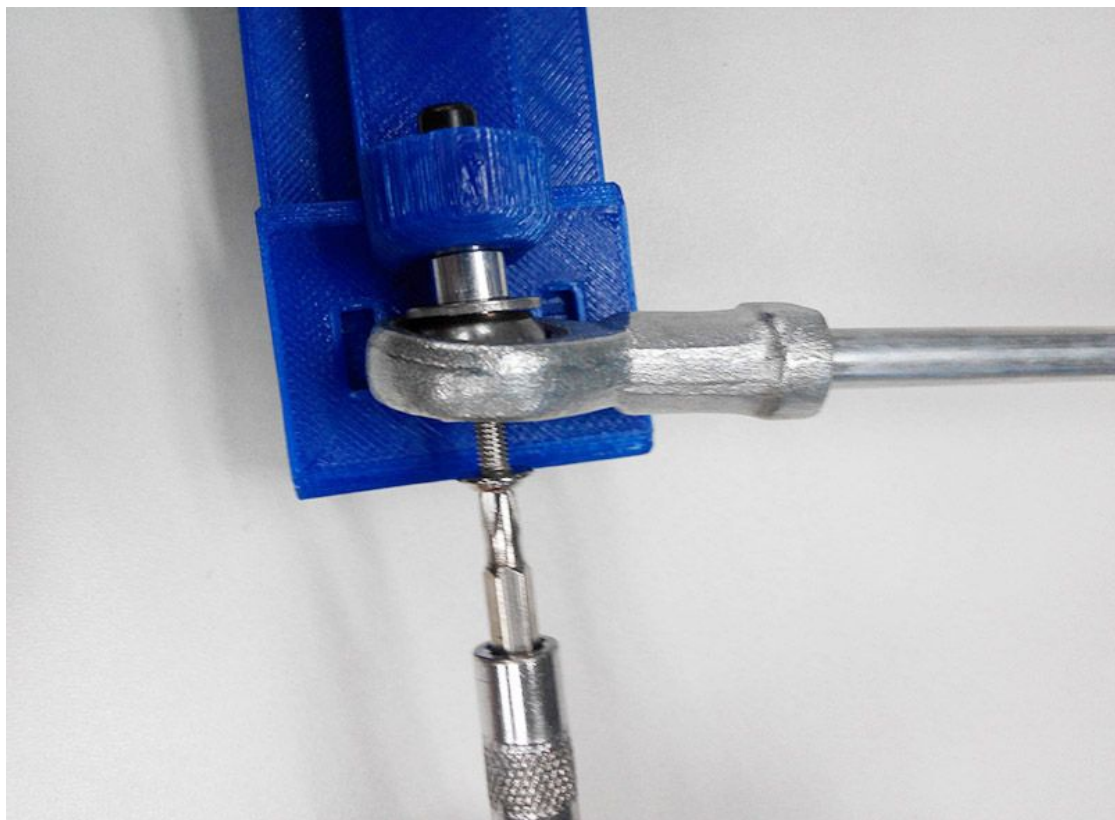

Step2. Repeat the above steps for the other diagonal rods. And mount another end of the diagonal rods to the spider.

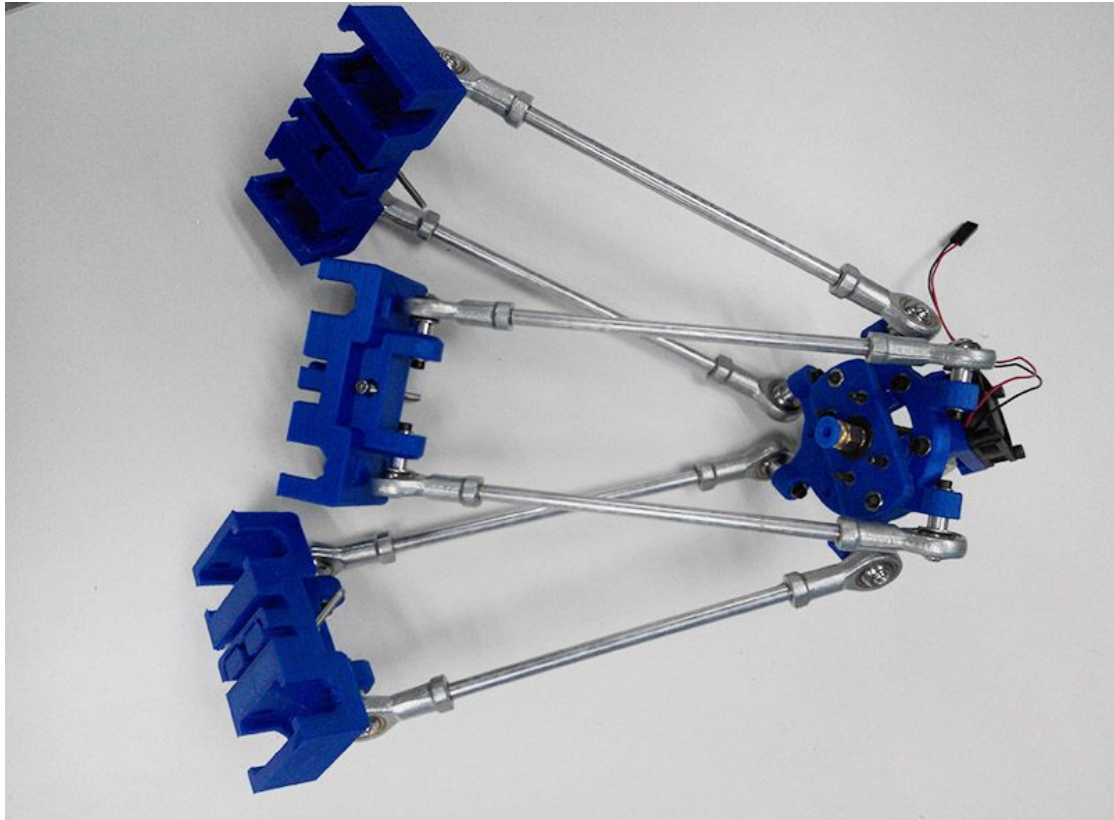

The directions should be as shown in the following picture.

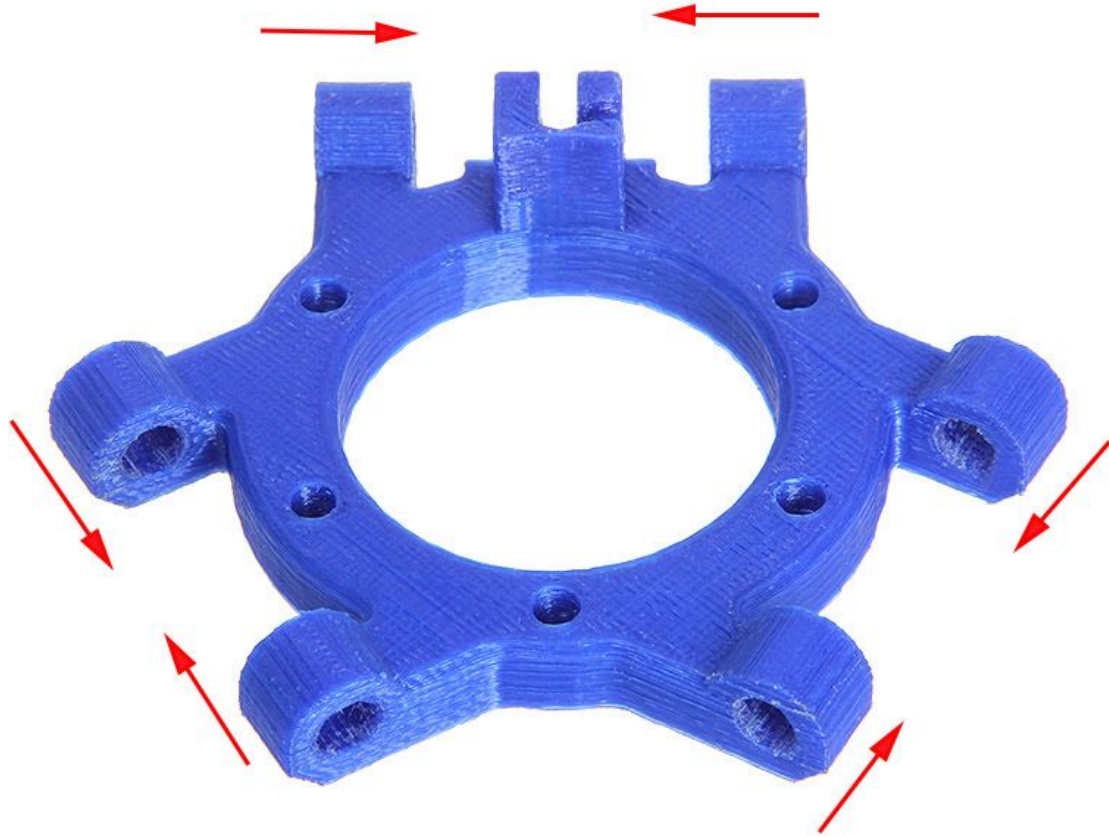

Step3. Insert the M3 x 40 screw into the carriage, this screw is for the hitting of the endstop.

As shown in the picture, there is a spring in between.

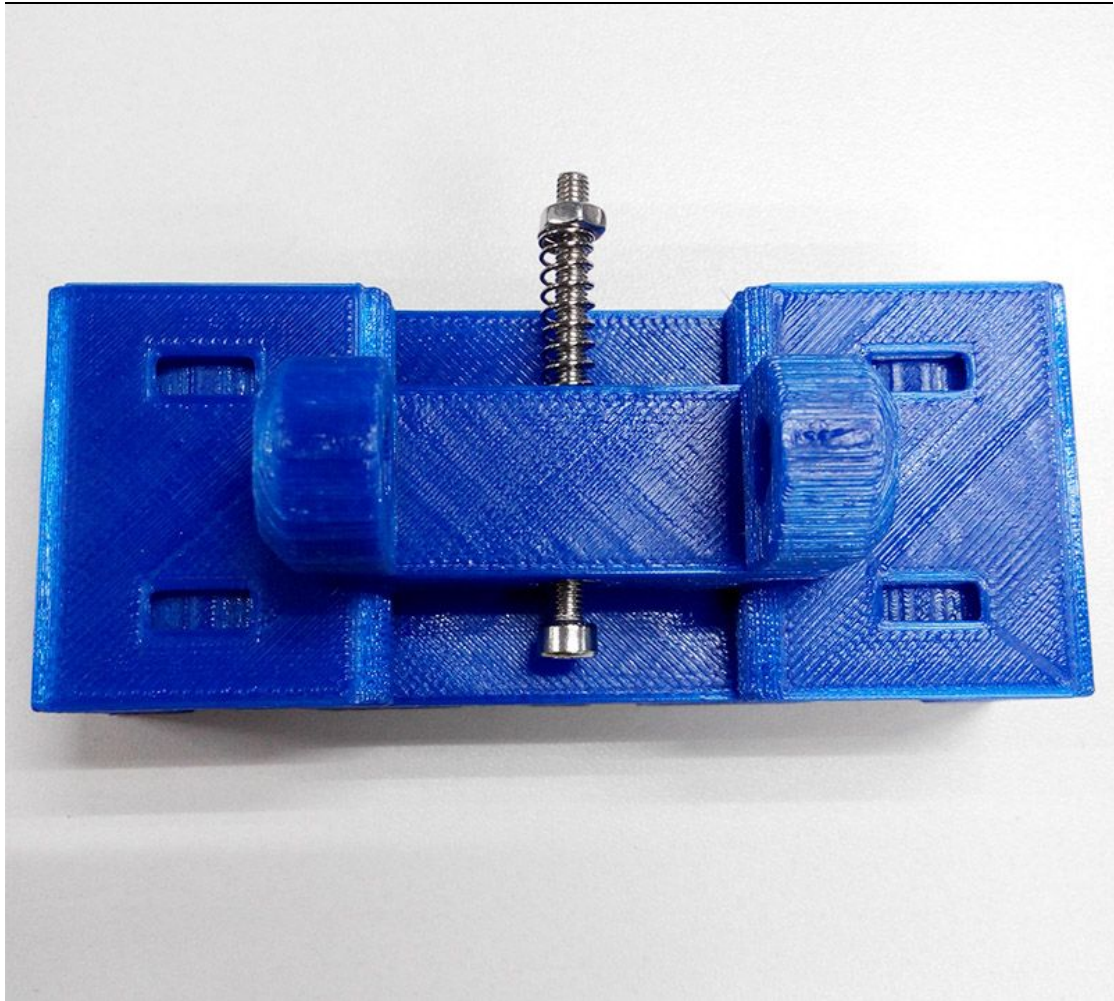

Step4. Connect the assembled print platform to the smooth rods.

Mount the carriage onto the rods where the linear bearing is, insert the bearings into the slot.

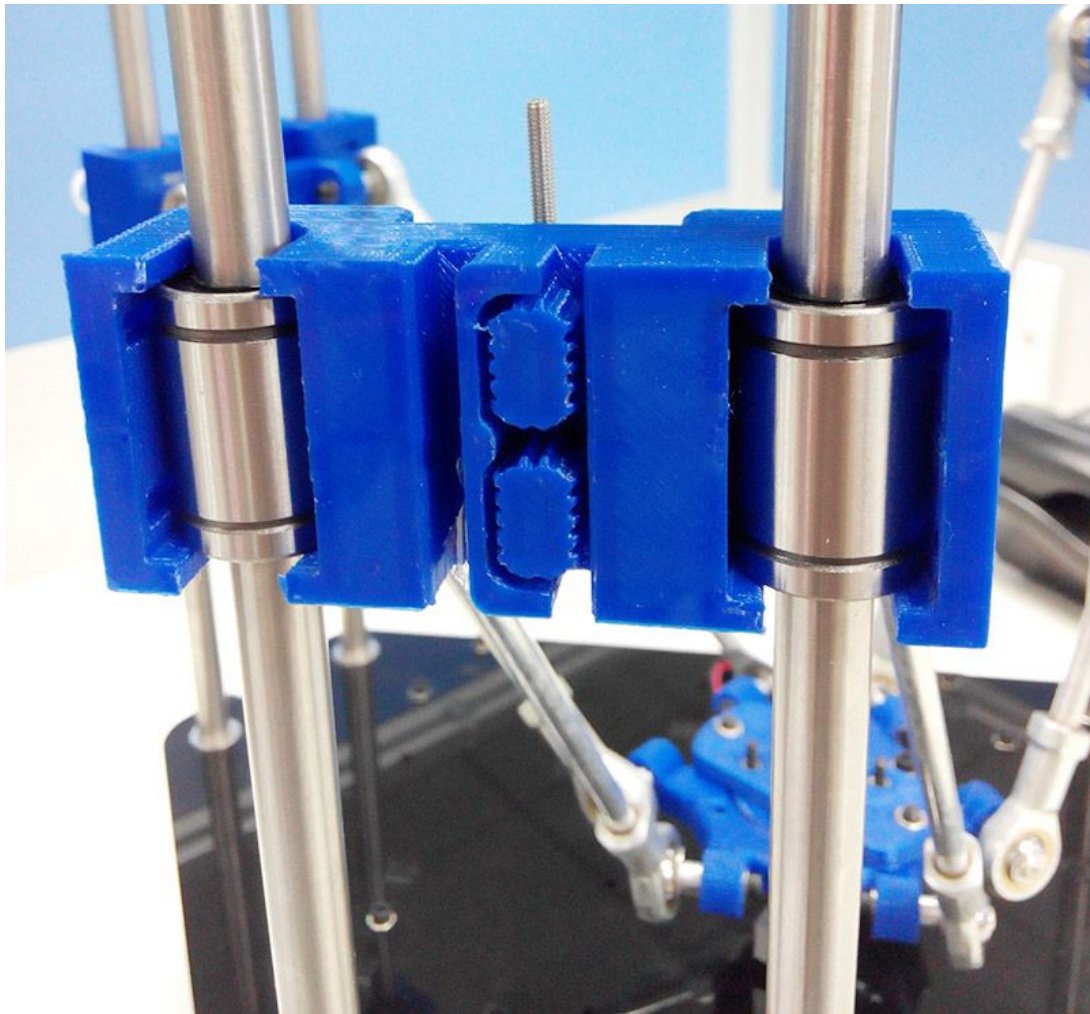

Step5. Tie up the carriage and the bearings with two zip ties.

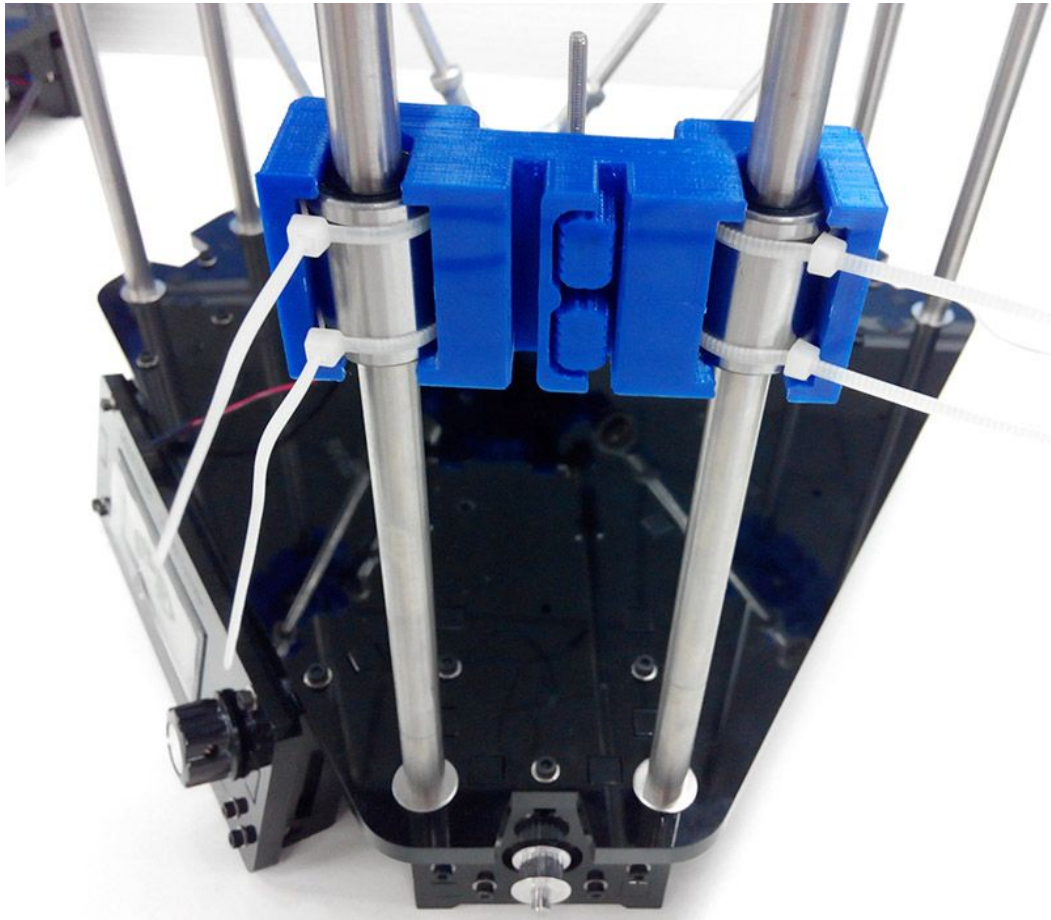

To help you see clearly, here is a detailed picture for the carriage.

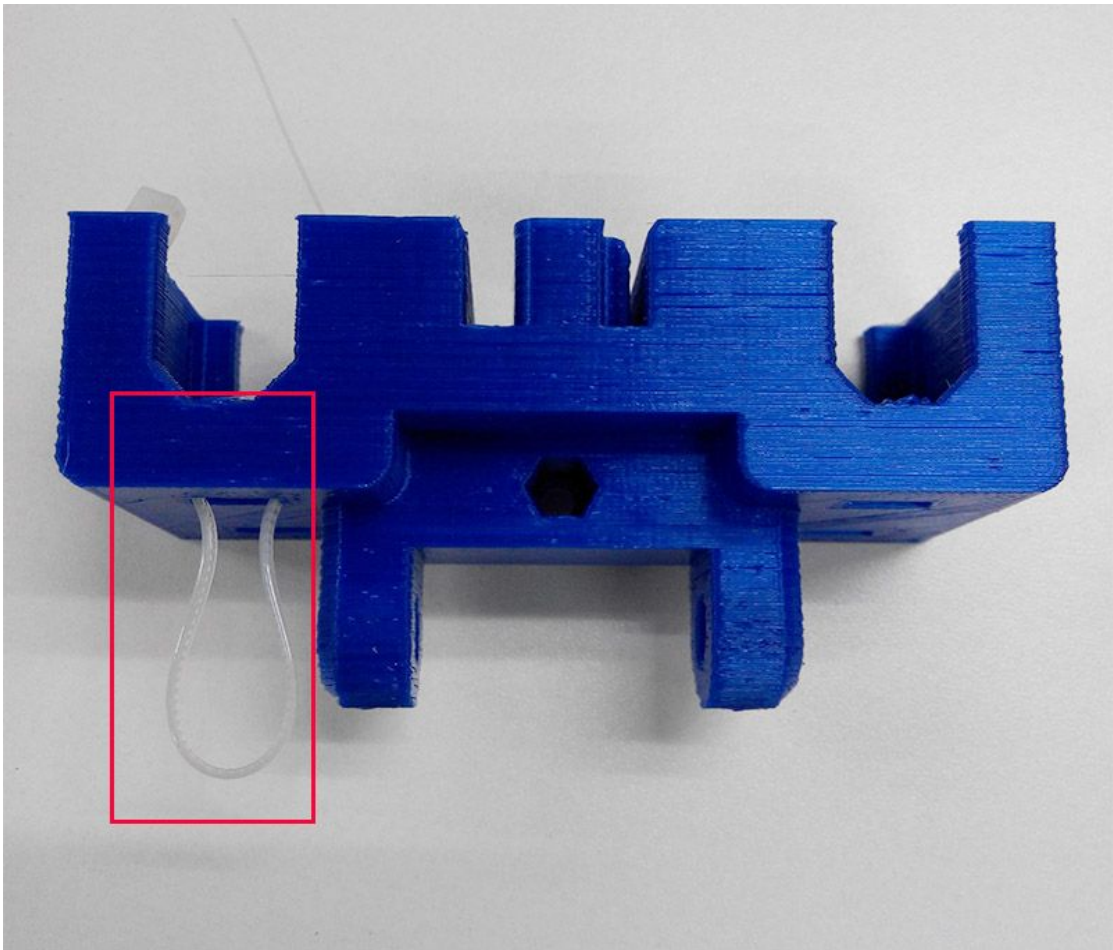
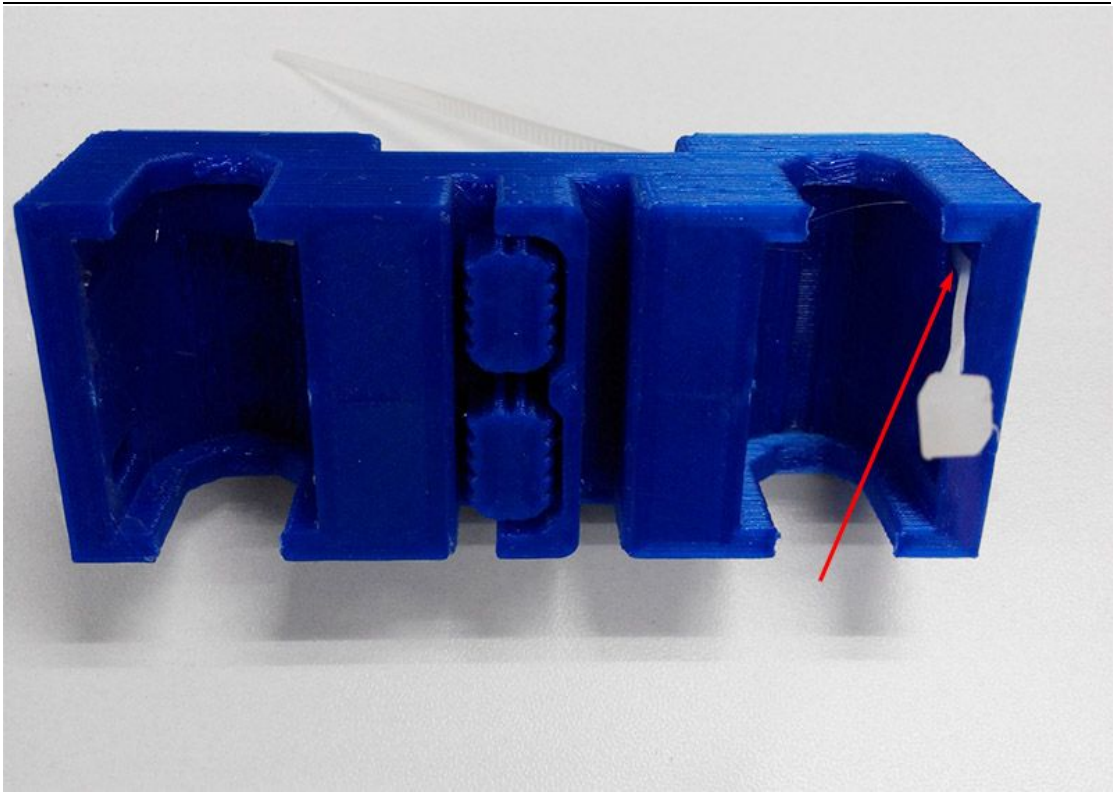

Chapter5 Mount the Belt

Name	Part NO.	Qty	Pic
Timing Belt	1	3	

Step1. Thread the belt through the drive wheel end. Pull it down to the pulley.

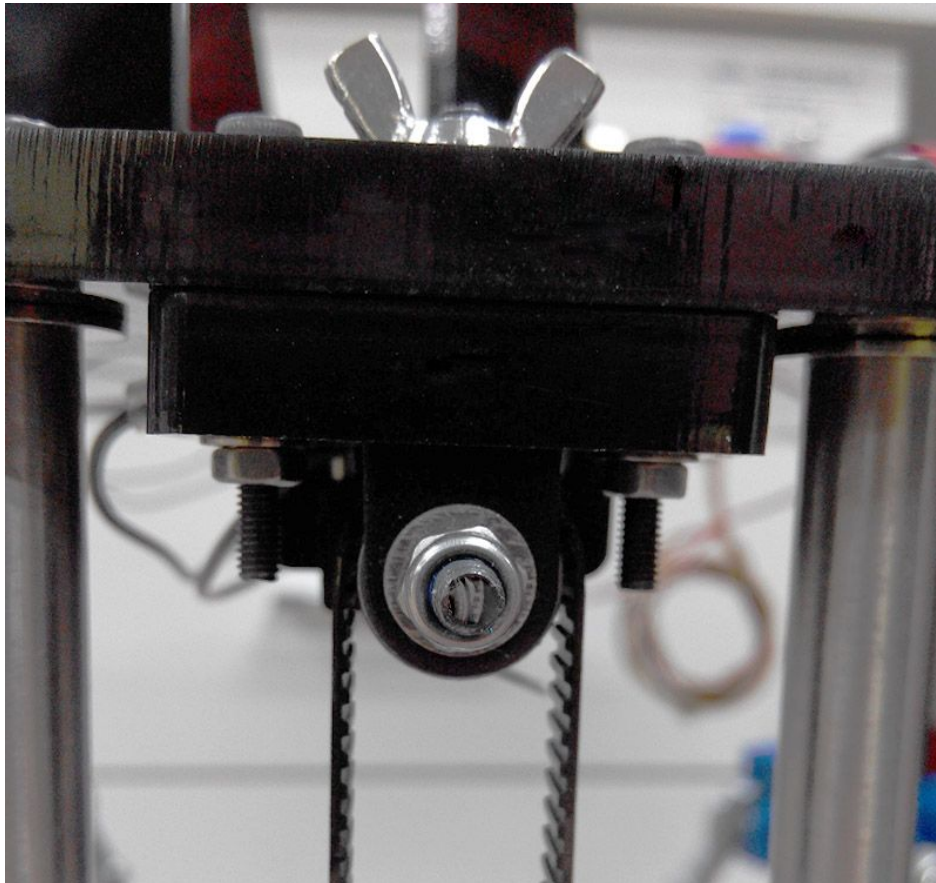

Step2. Thread the belt around the pulley, and take both ends to the carriage.

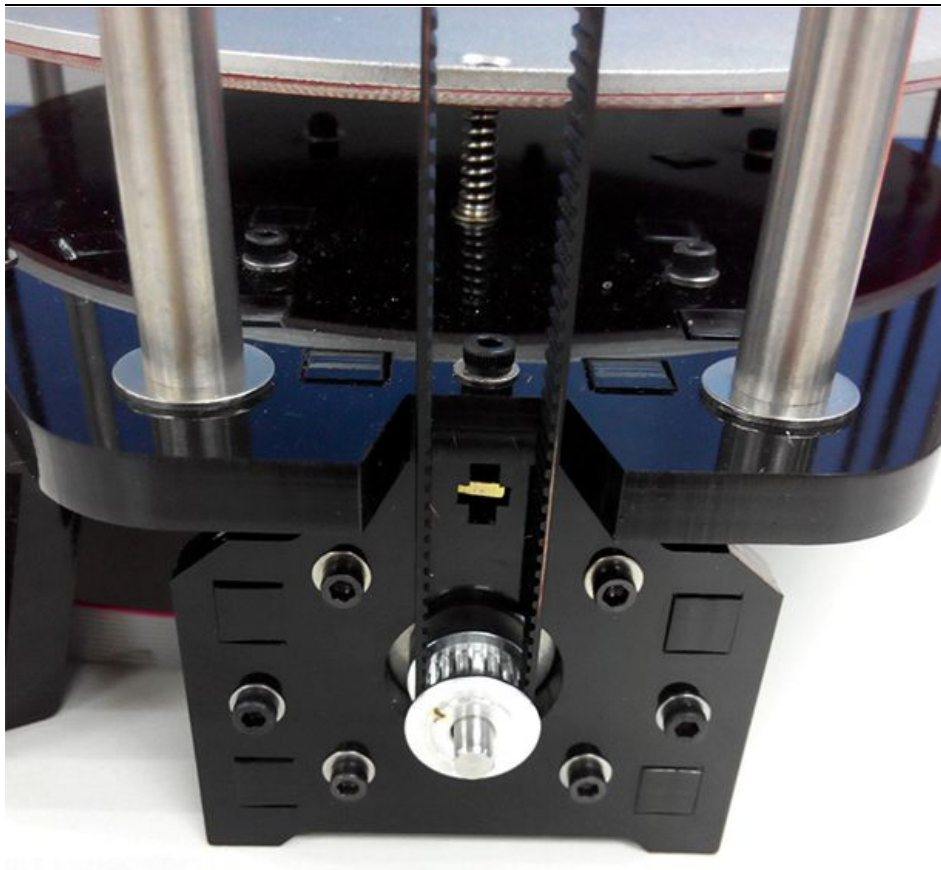

Step3. Insert the belt into the slot. If the slot is too thin, you can use the grater to file it larger. Tie up the belt if needed.

*Pay attention to the tooth mesh of the belt and that on the bracket. Tie up both ends tightly.

*The belt should be neither too tight nor too loose, you can slide the carriage up and down to see if it is

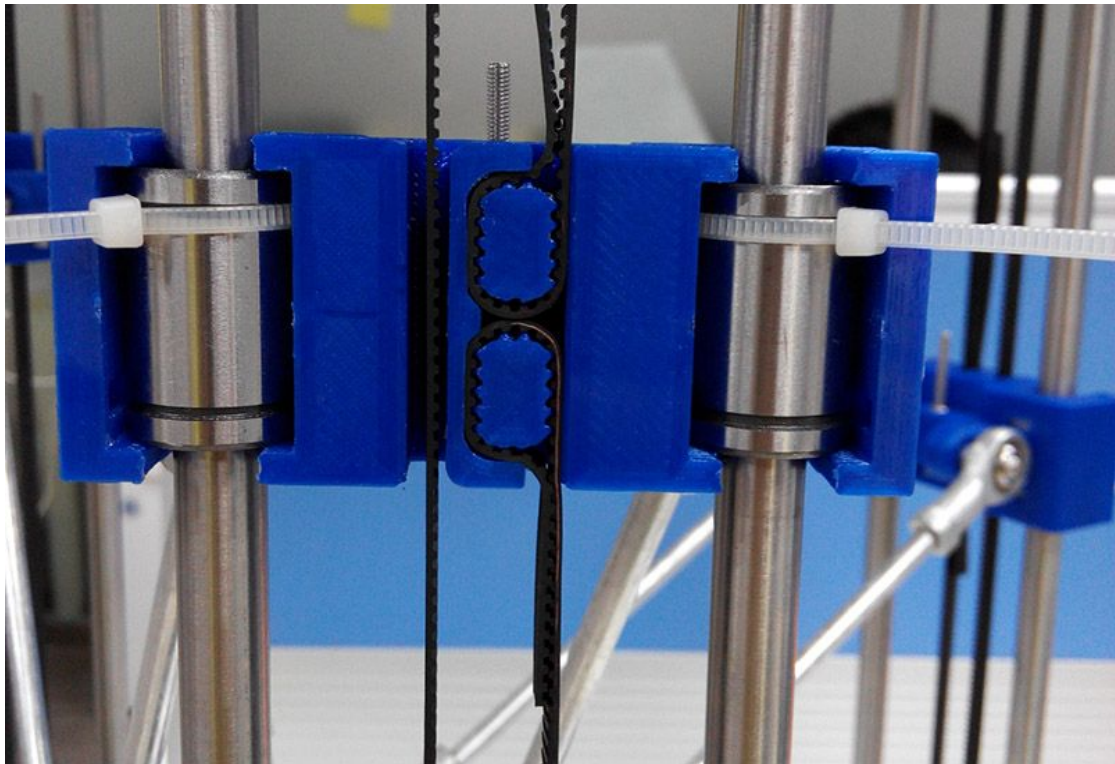

To help you better understand this step, here is a short video for you to refer.

<https://www.youtube.com/watch?v=RP-J7jWmabg>

Repeat the above steps for the other 2 belts.

Chapter6 Connect the PTFE tube

Name	Part NO.	Qty	Pic
Feeding pipe	1	1	

Step1. Plug one end of the tube into the push-fitting on the hotend and the other end into that of the extruder.

* If you need to pull the tube out, please press the blue part while pulling.

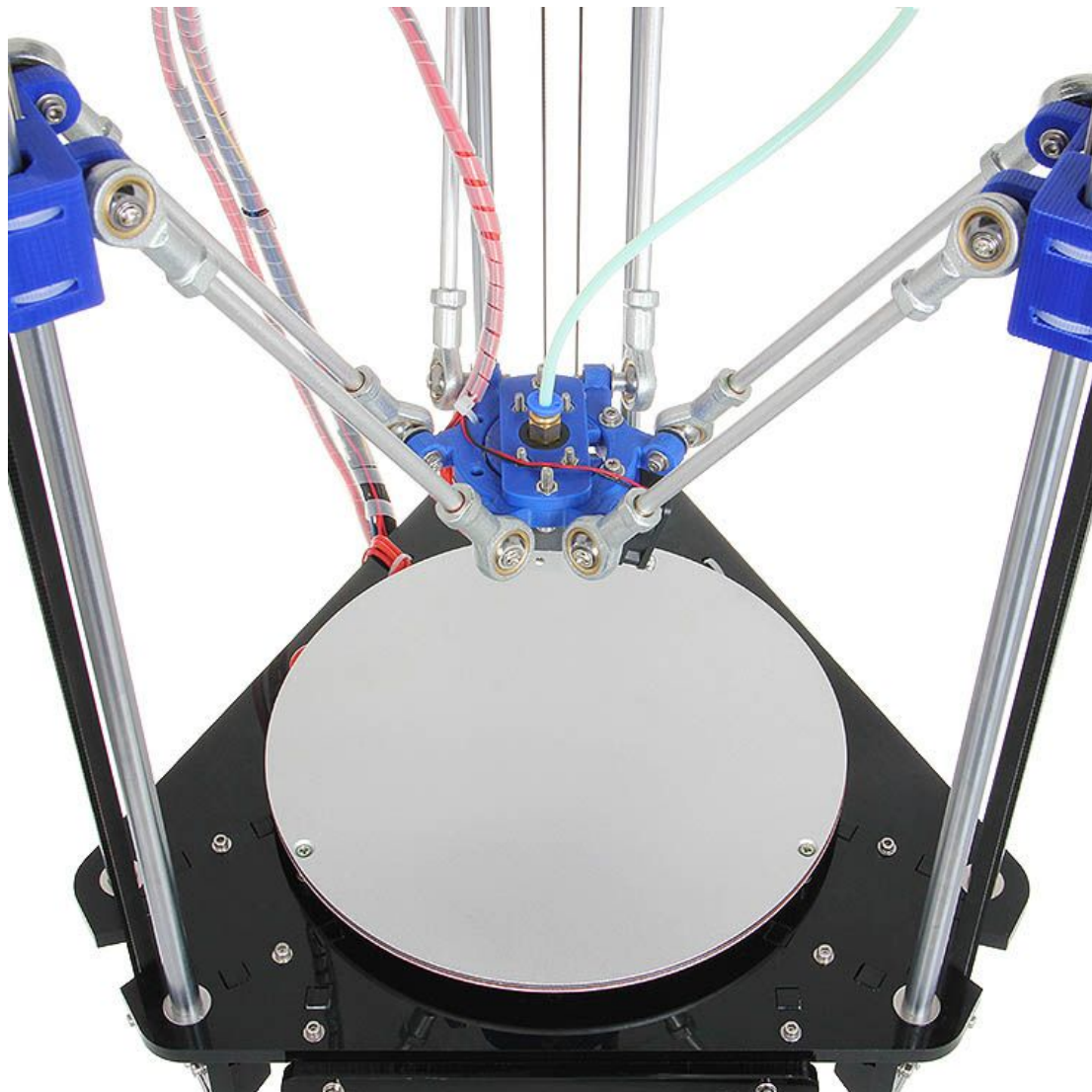

Chapter7 Wiring

Before you start wiring, please take a look at the wiring schematics.

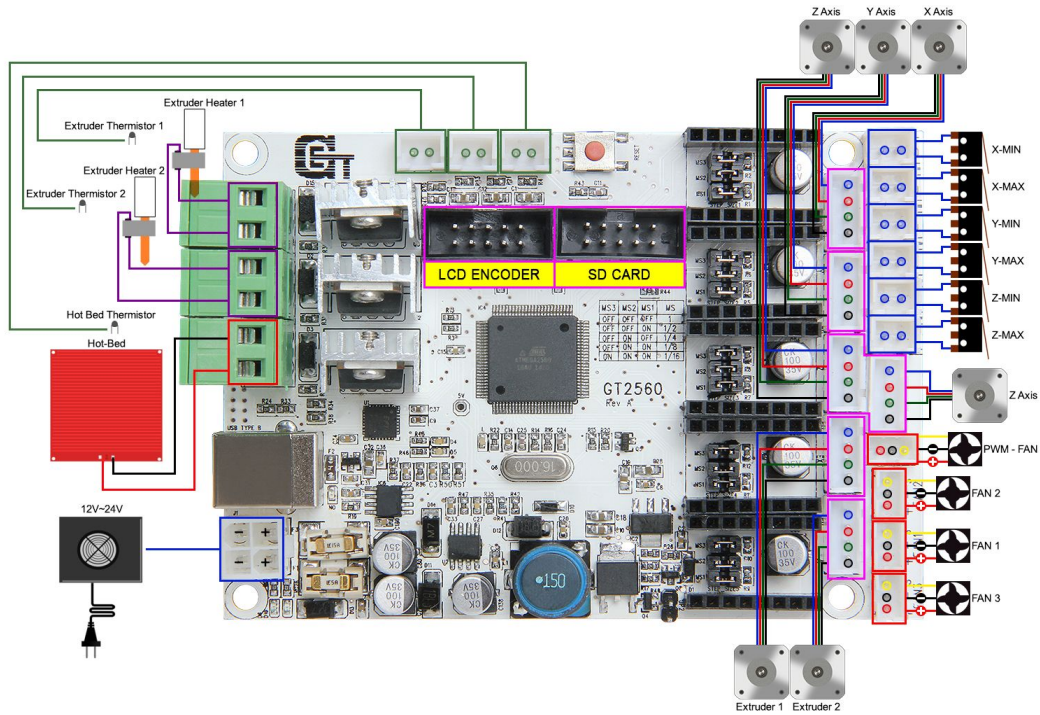

You can see original picture [here](#).

Step1. Connect wires for motors.

1) Connect wires for X-axis motor.

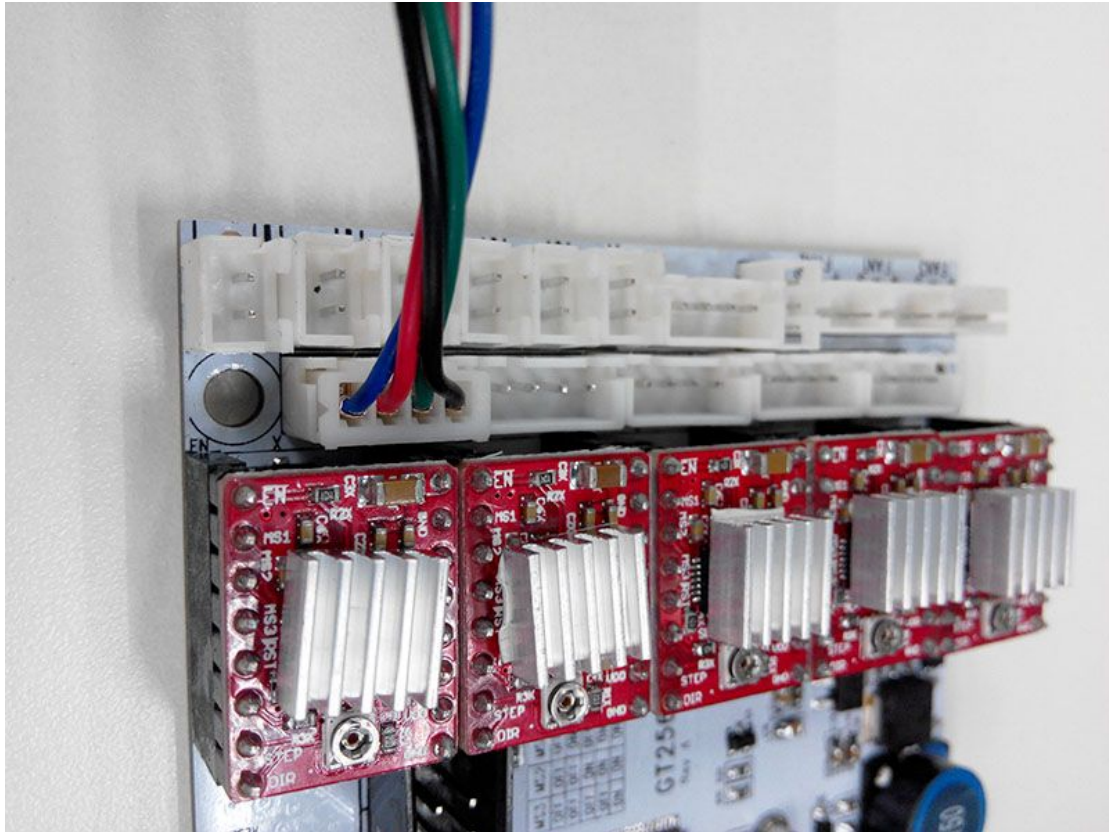

2) Connect wires for Y-axis motor.

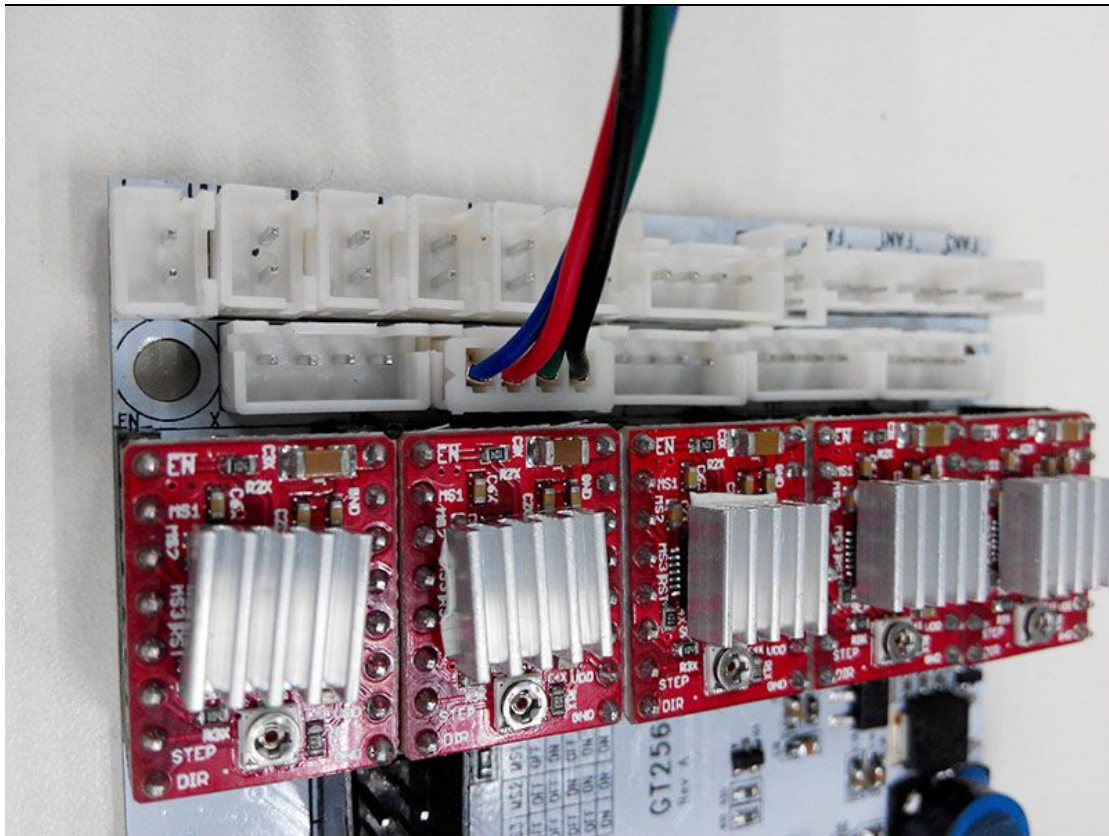

3) Connect wires for Z-axis motor.

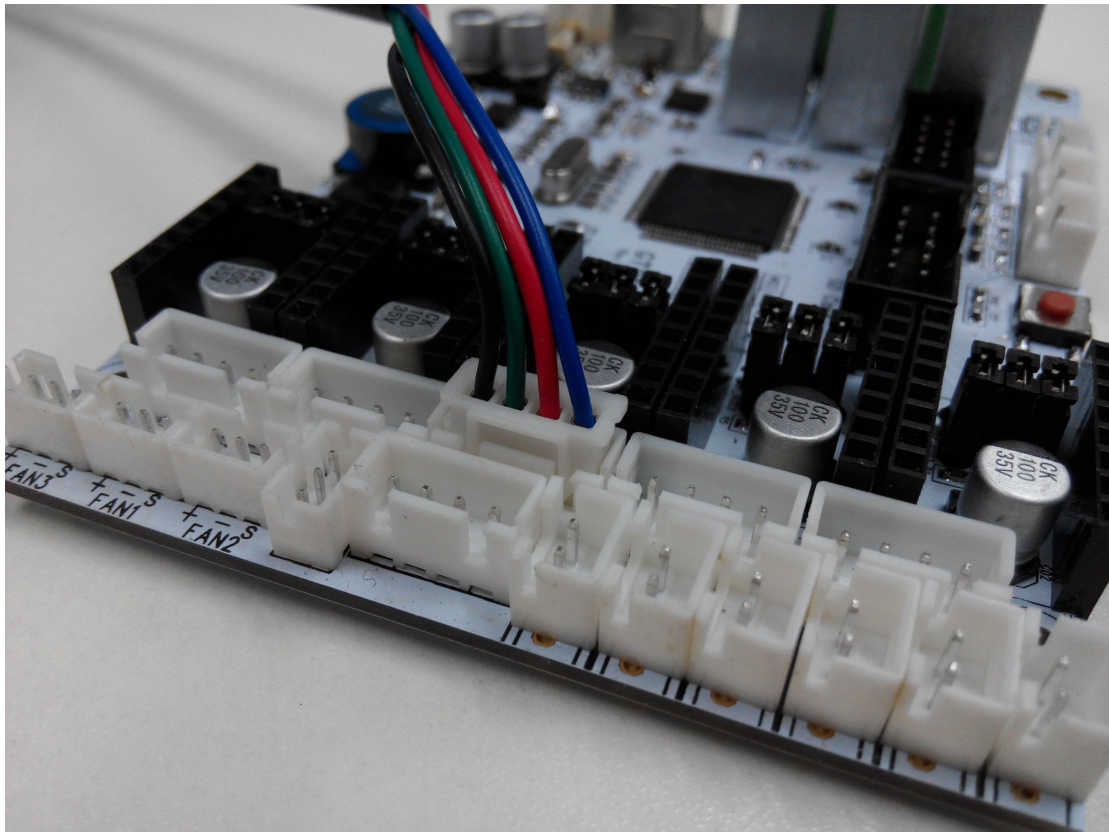

For G2s, connect the second Z motor here.

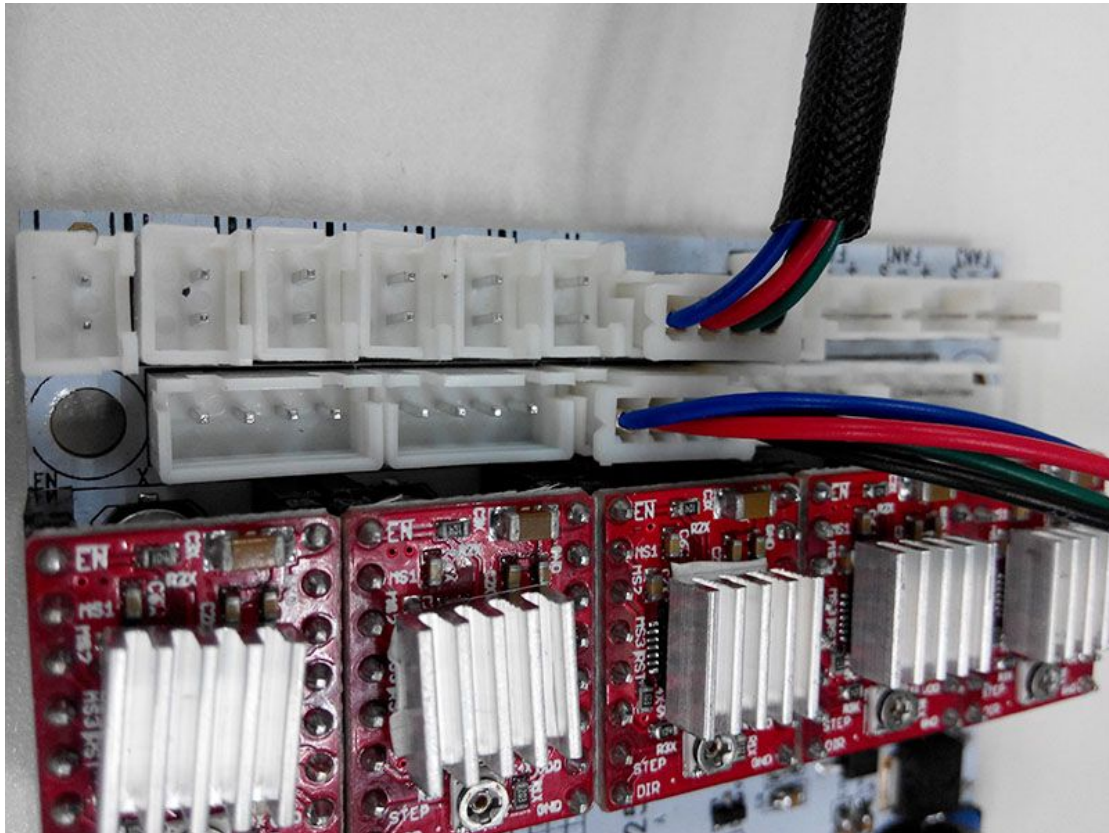

4) Connect extruder motor

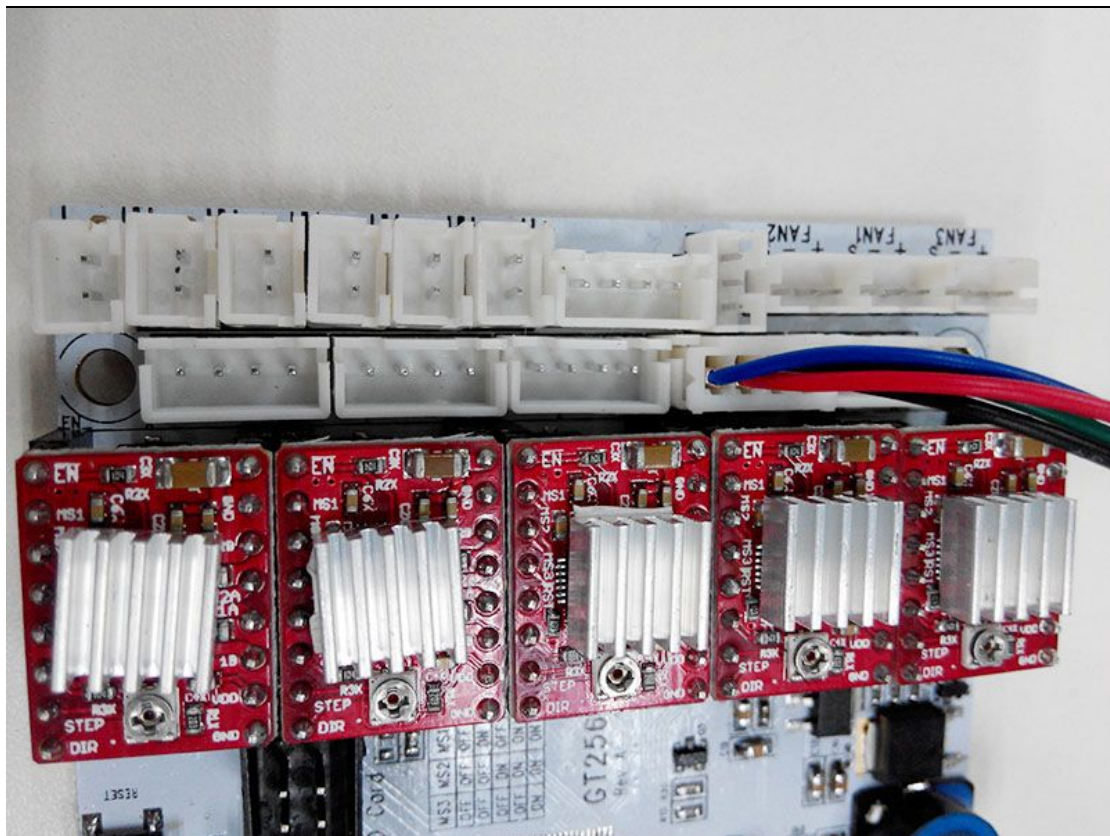

Step4. Connect heating wires.

Loosed the screws in the green terminal and put the red wires into the slot and screw it up.

* There is no “+” and “-“for heating wires

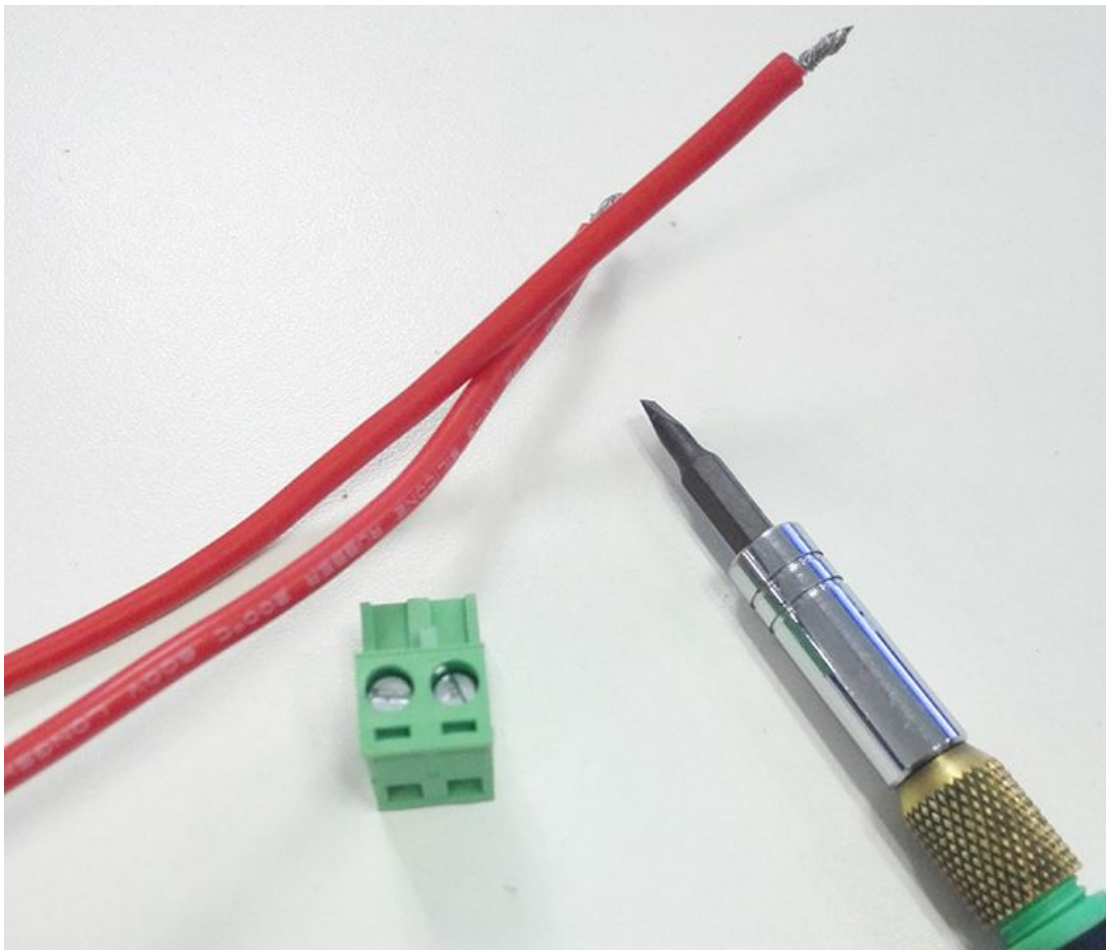

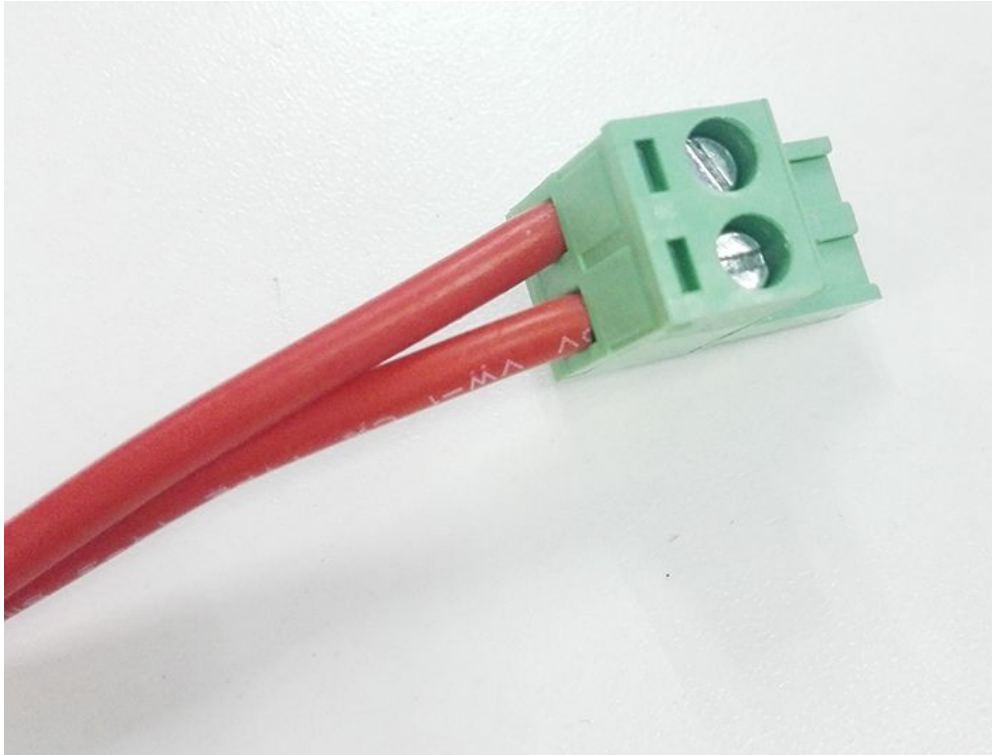

- 1) Connect heating wires for heatbed.

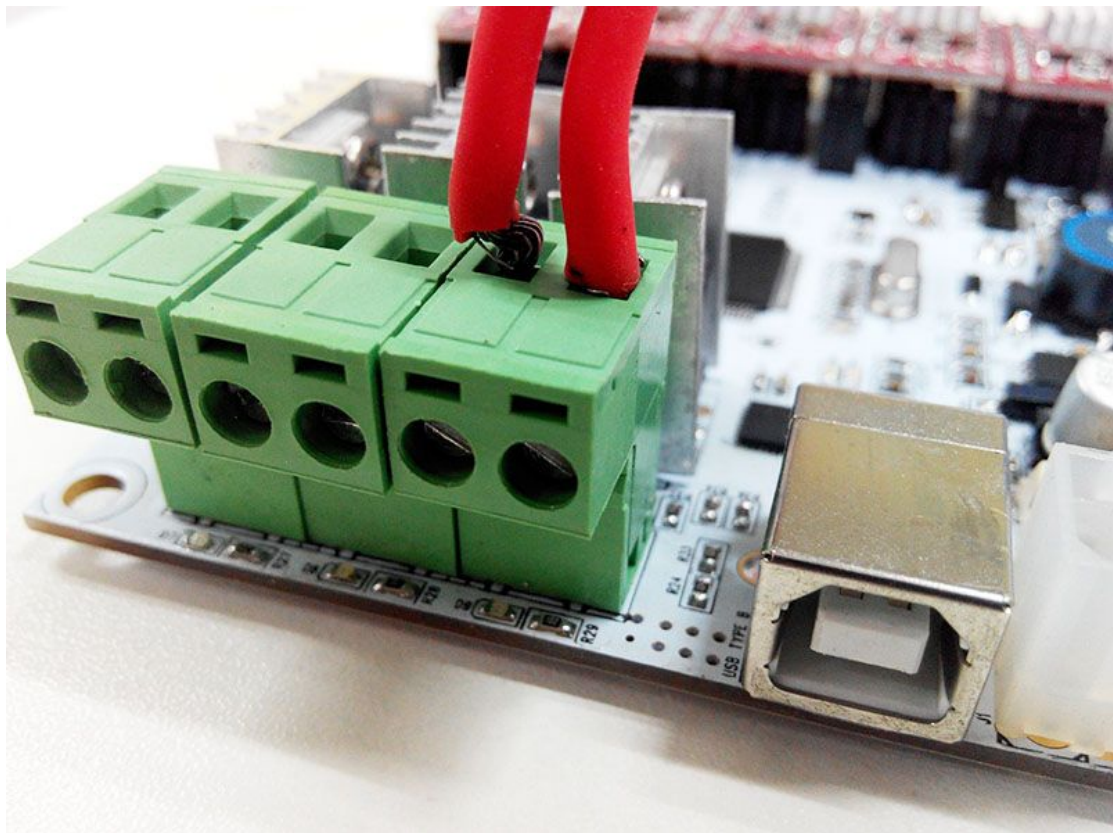

- 2) Connect heating wires for extruder 0.

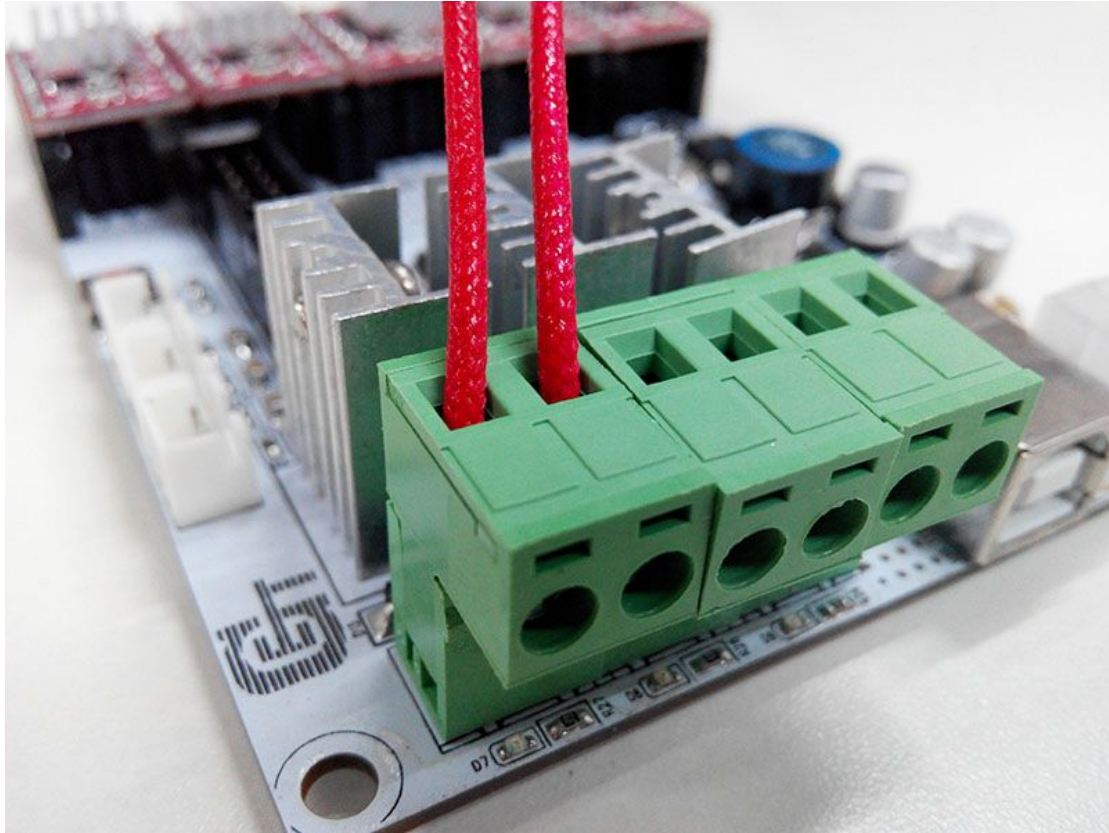

- 3) Connect heating wires for extruder 1. (needed if you are building G2s)

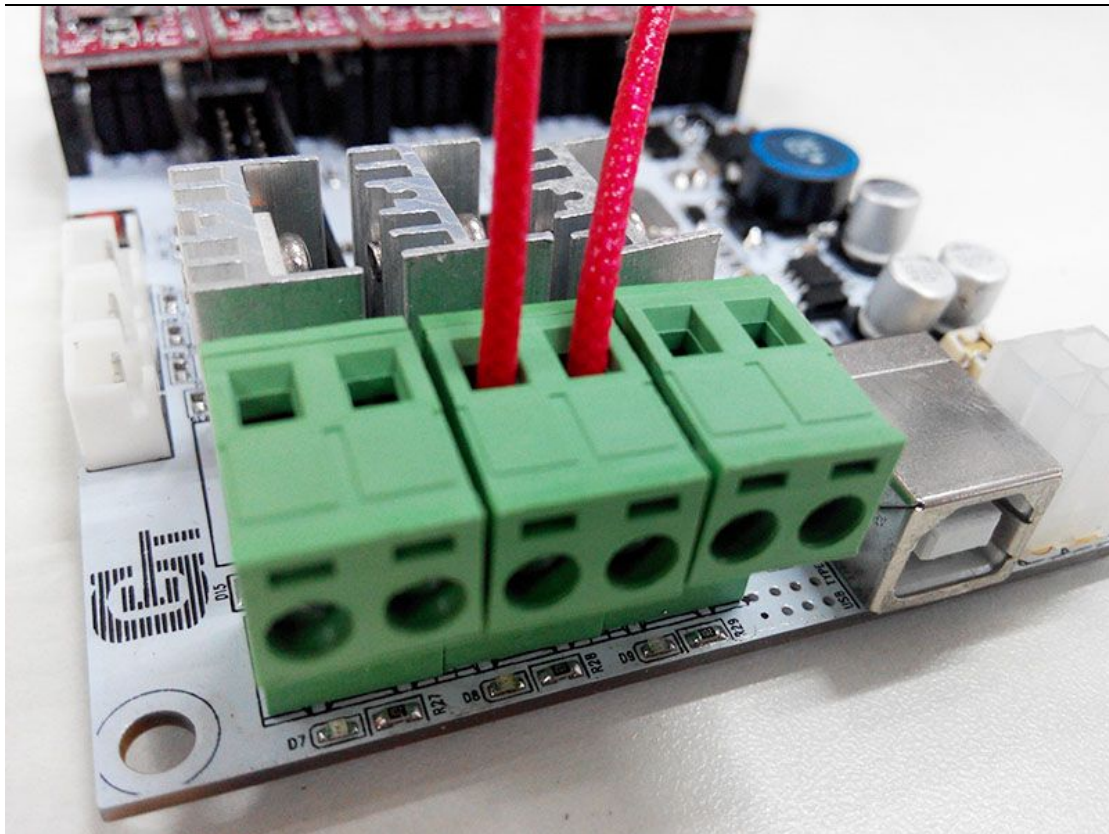

Step4. Connect wires for thermistor.

- 1) Connect wires for thermistor of heated.

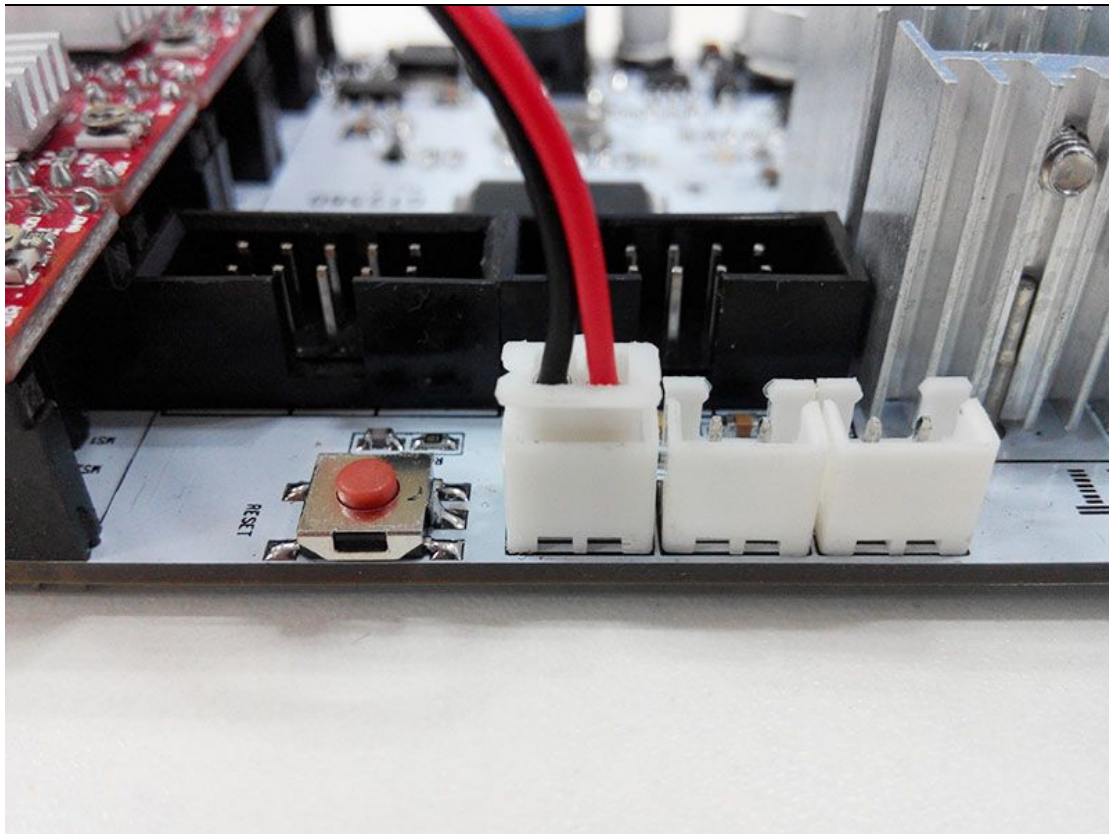

2) Connect wires for thermistor of extruder 0.

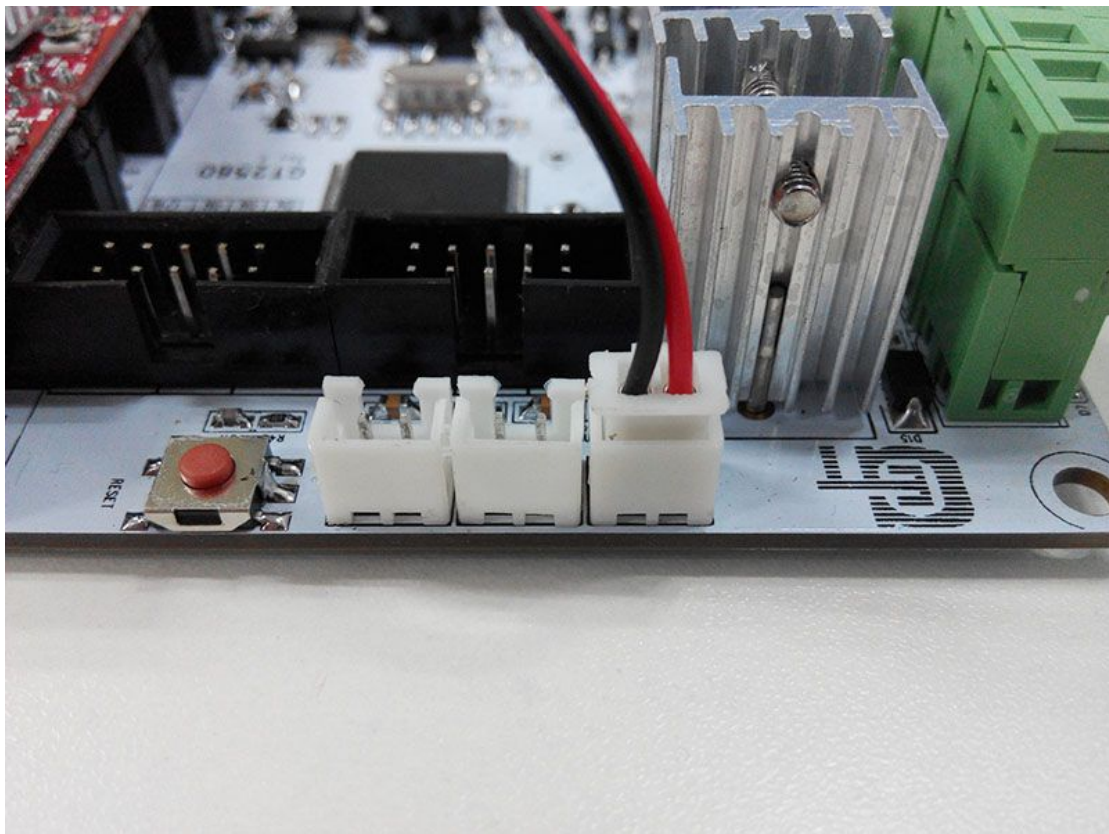

3) Connect wires for thermistor of extruder 1. (needed if you are building G2s)

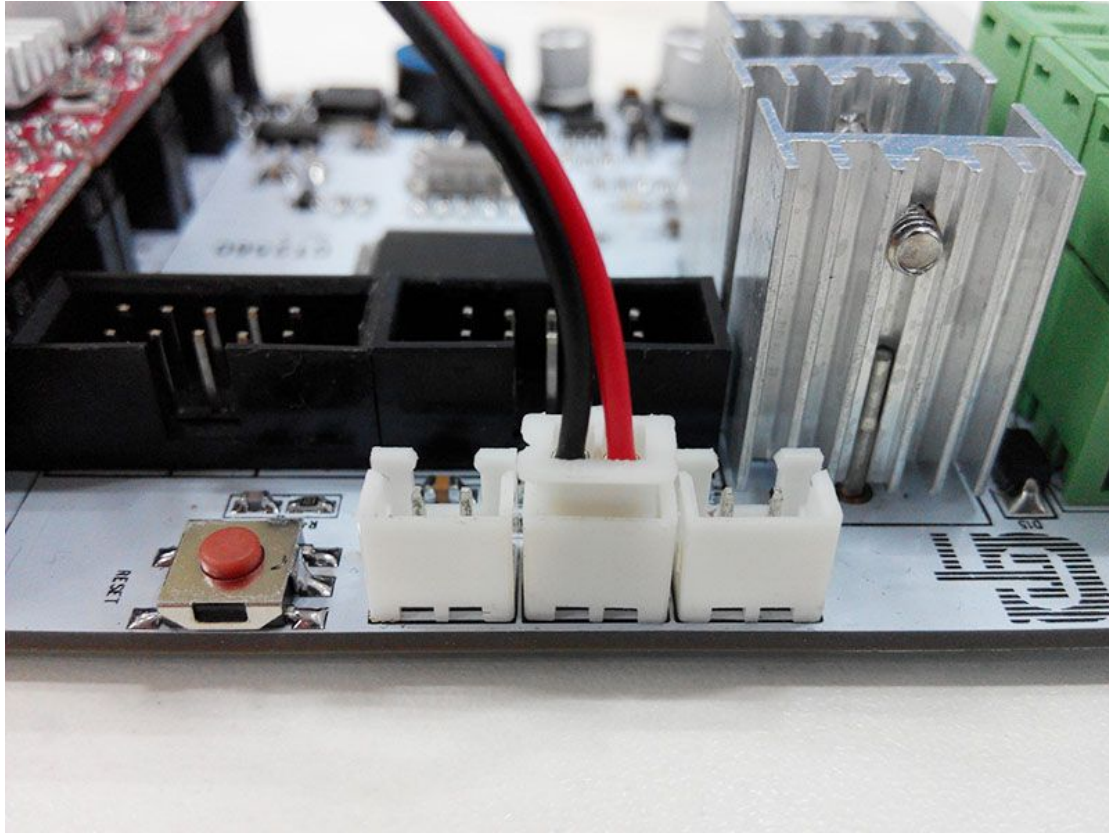

Step5. Connect wires for endstop.

1) Connect wires for endstop of X-axis at X-max.

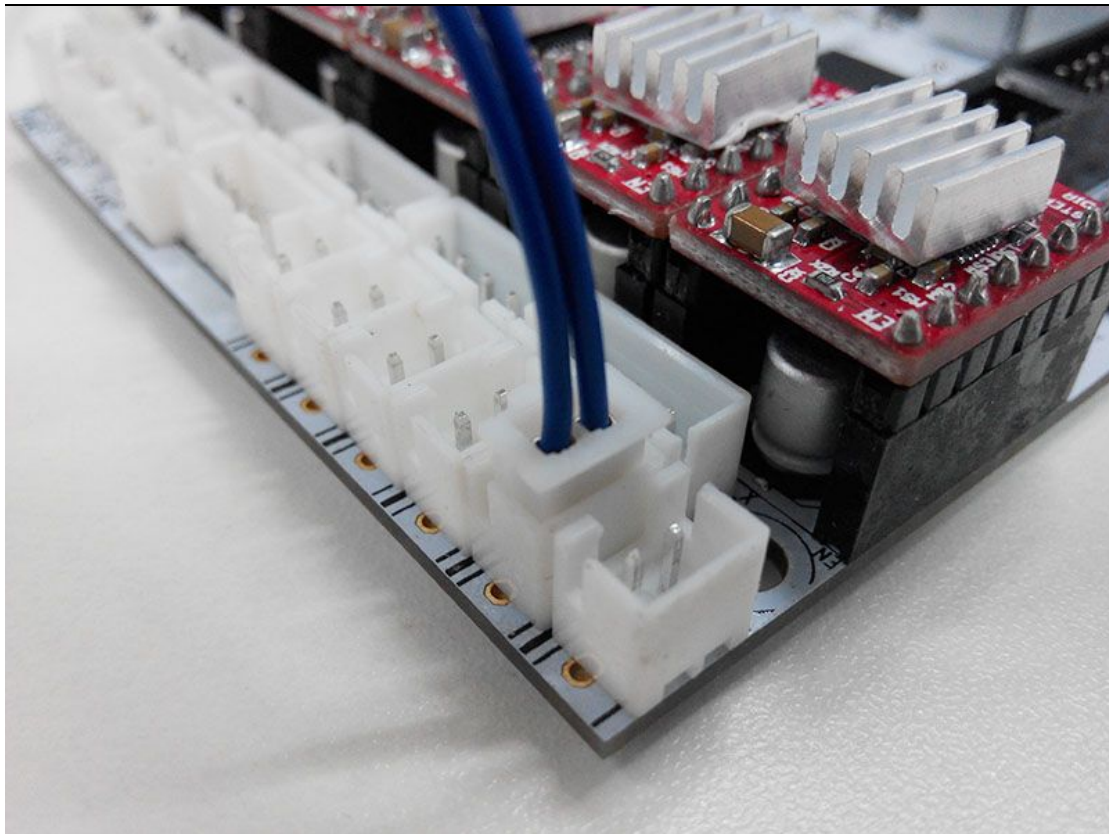

2) Connect wires for endstop of Y-axis at Y-max.

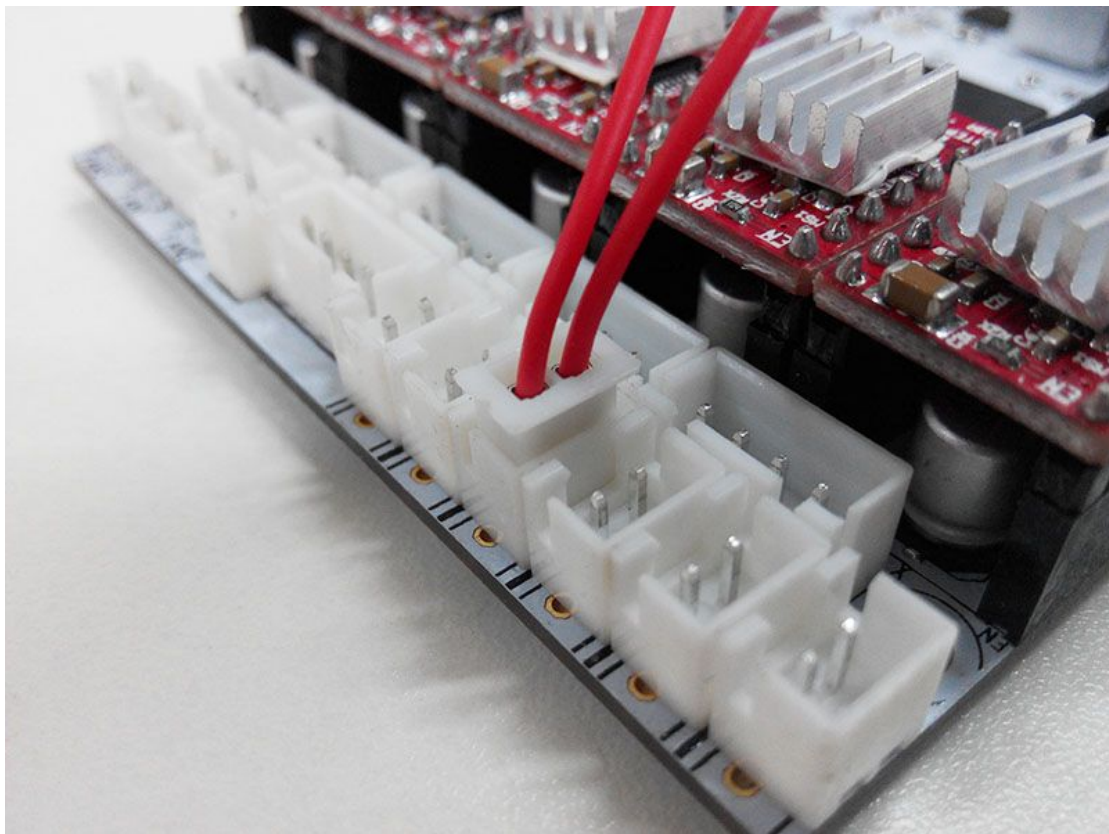

3) Connect wires for endstop of Z-axis at Z-max.

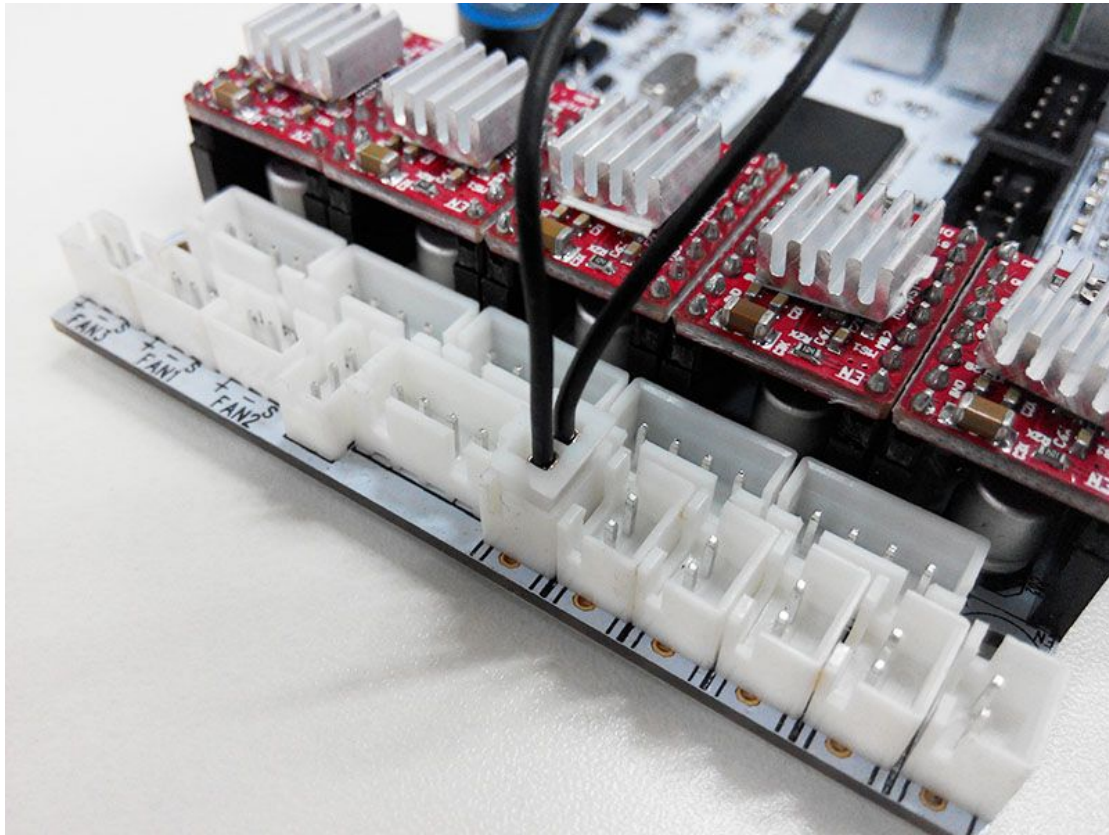

3) Connect wires for endstop of auto-leveling probe at Z-min.

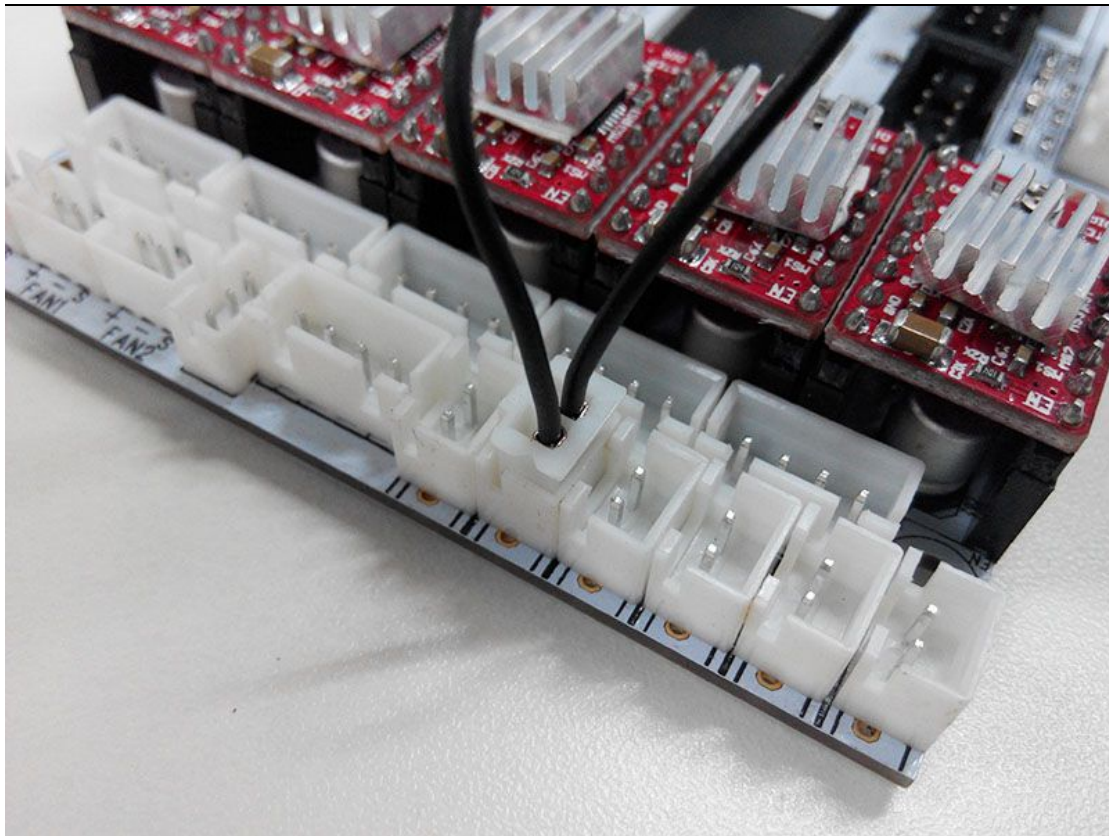

Step6. Connect wires for Fan.

- 1) Connect fan for control board at FAN1.

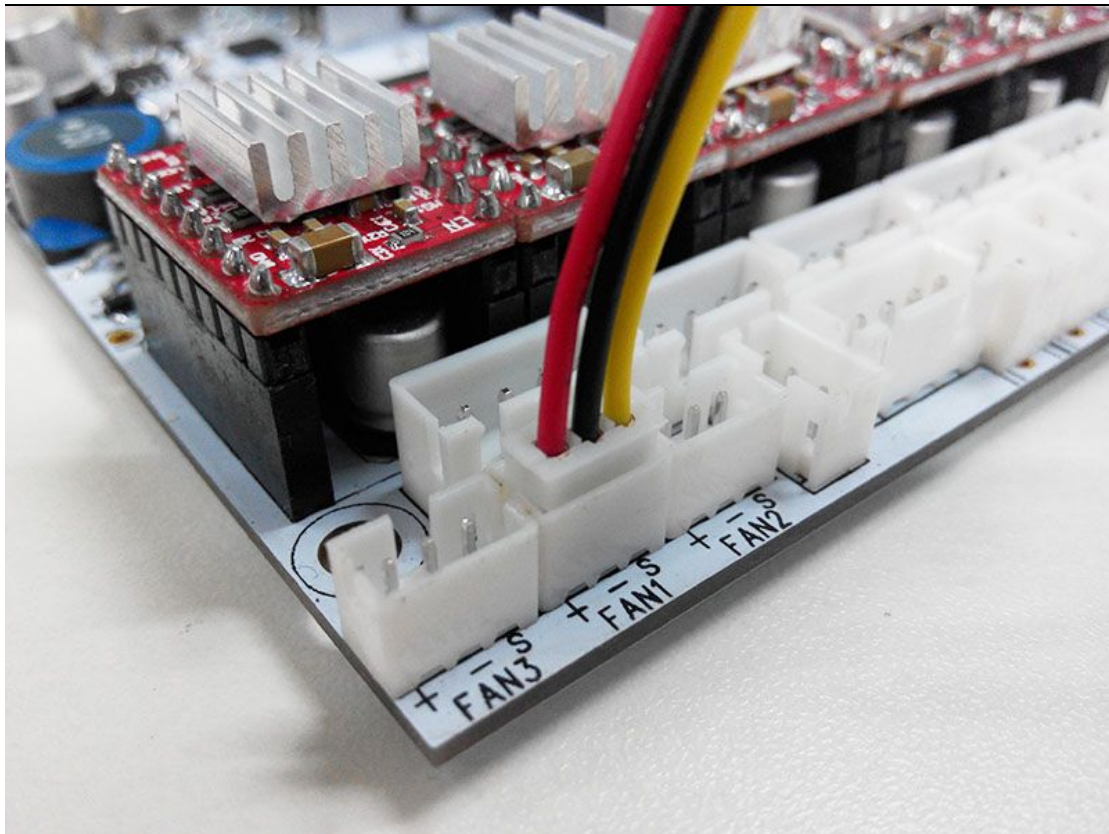

2) Connect fan for extruder at FAN3.

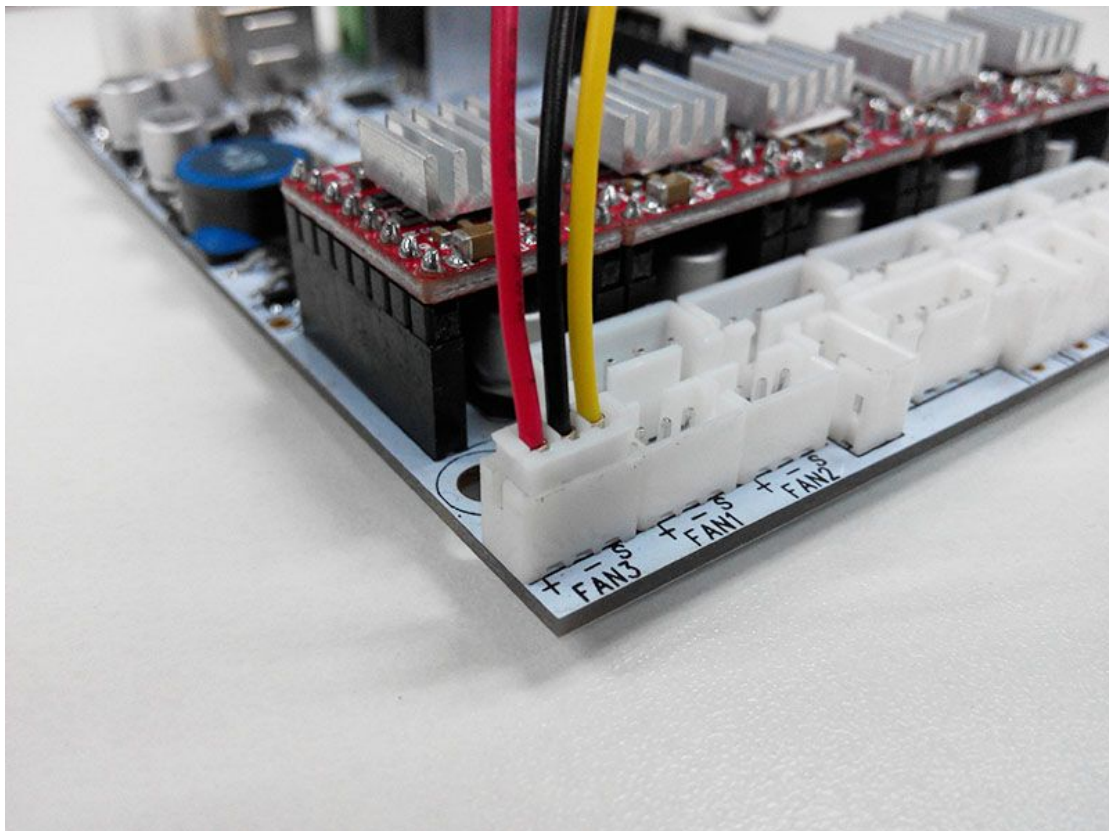

If you use the 2-pin extension wire for the fan, just plug them on the + and - of the slot.

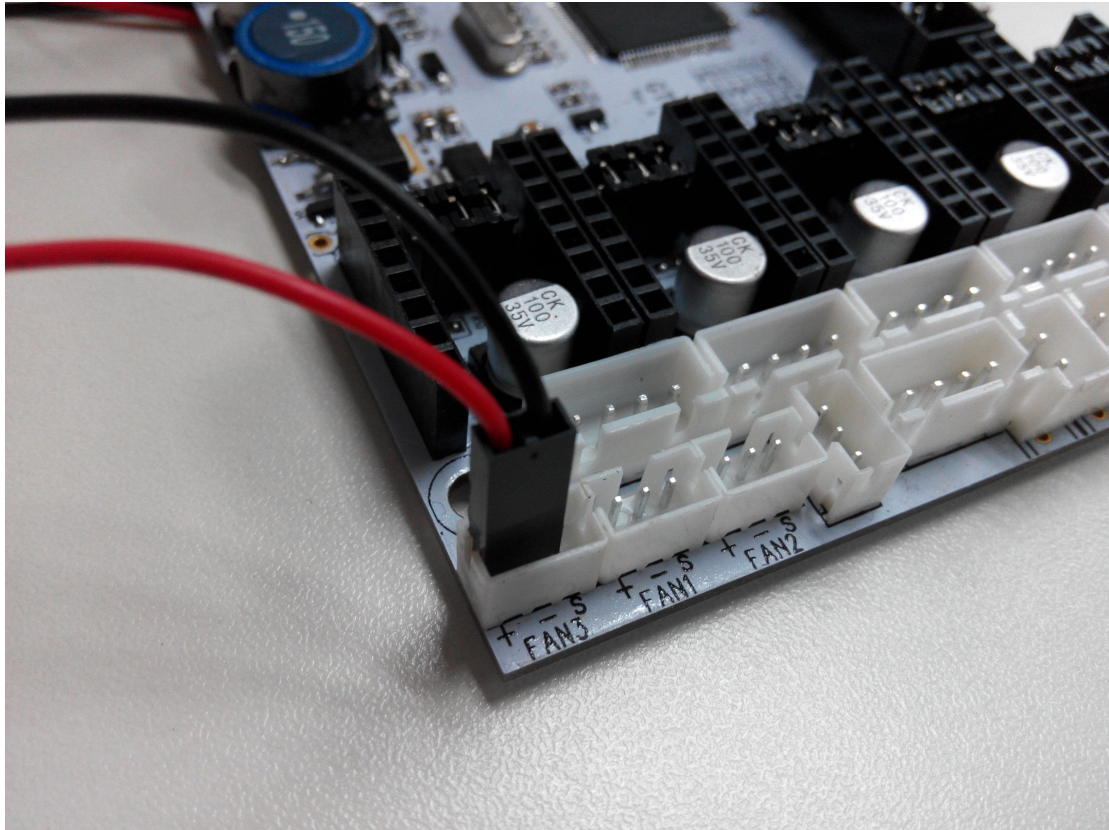

2) Connect fan for hotend at FAN-PWM.

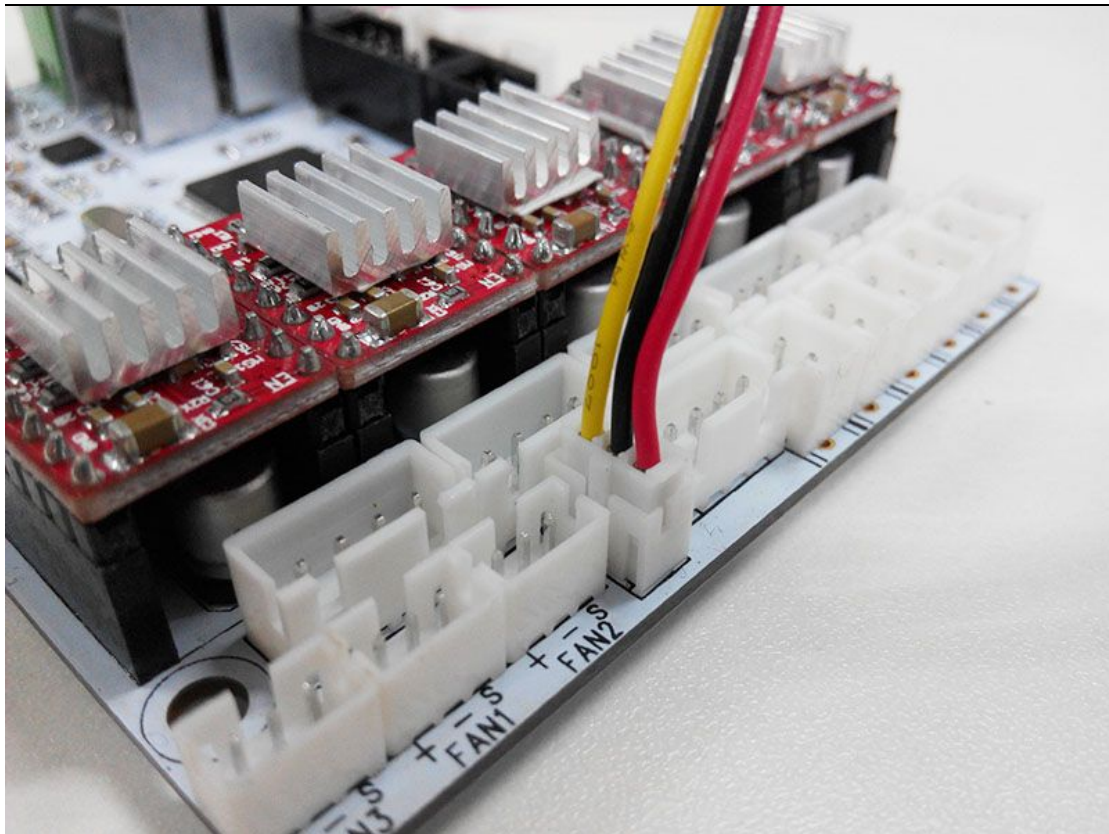

Step7. Connect wires for LCD panel.

There are two cables, one is for LCD encoder, the other is for SD card, do not connect them reversed.

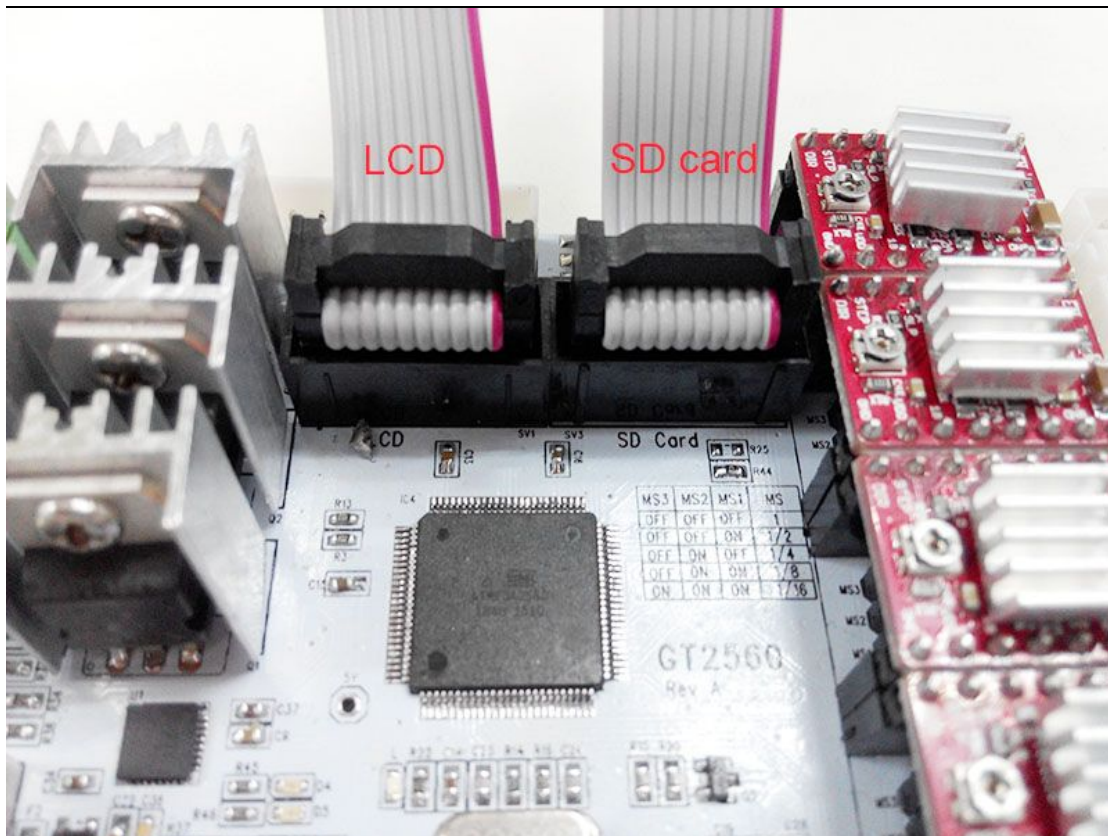

Step8. Connect wires for power input.

Name	Part NO.	Qty	Pic
Power cable	48	1	

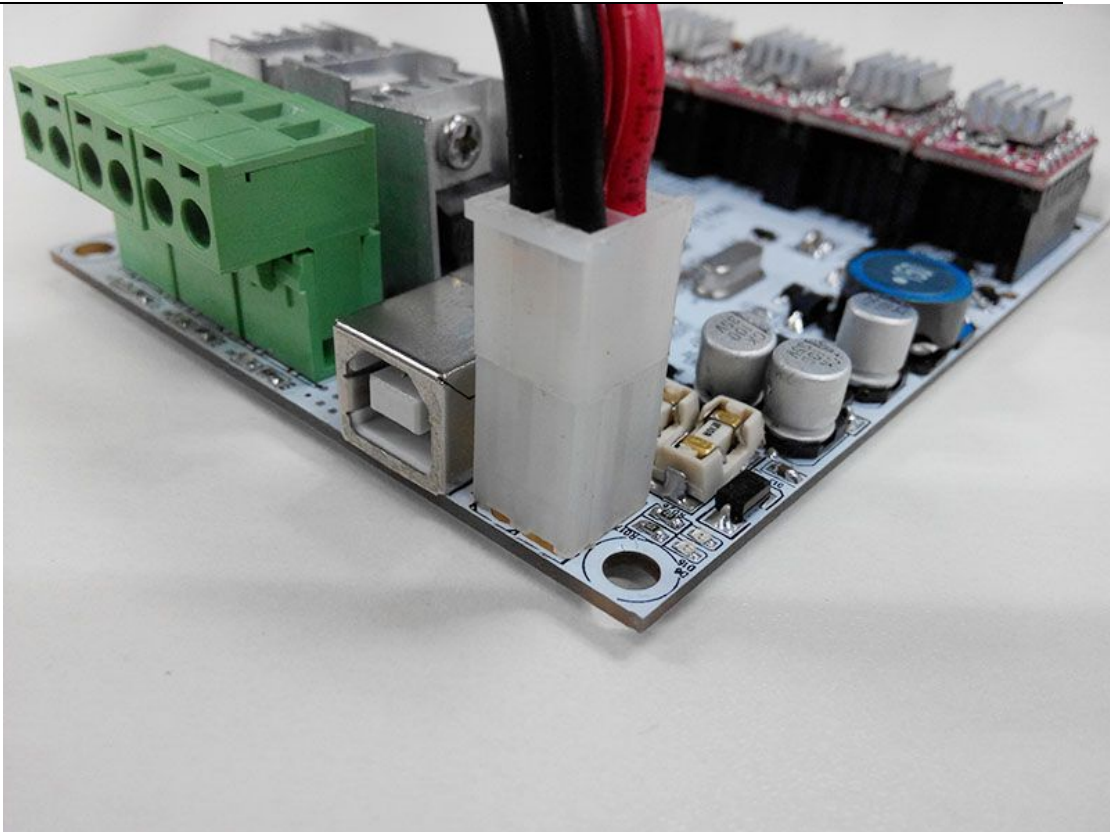

Plug the other end into the PSU. Do not forget to cover it.

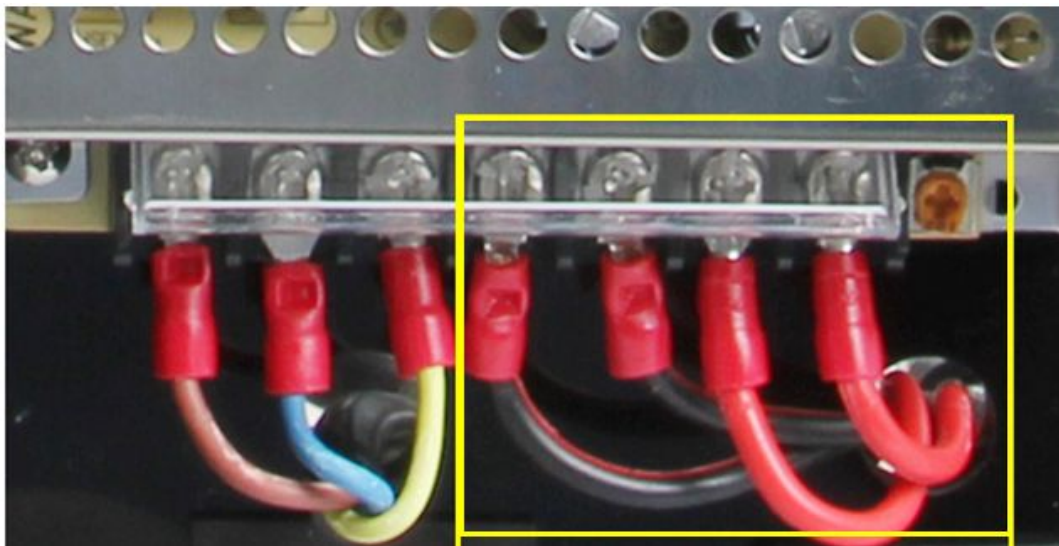

Step9.Connect the power cable to the input connector of PSU

Name	Part NO.	Qty	Pic
3D Power cable	49	1	

As shown in the red box.

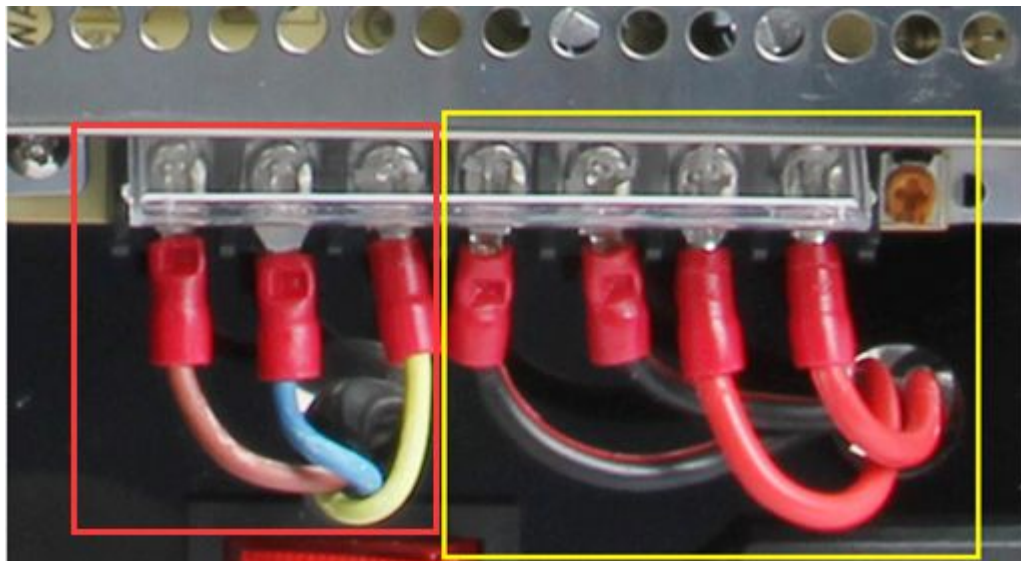

That is all for the wiring of GT2560.

As there is no place for the PSU on this printer, you should take good care of it; keep it away from kids and pets.

Chapter8 Tidy out the wires

Use the spiral coil to tie put those wires together.

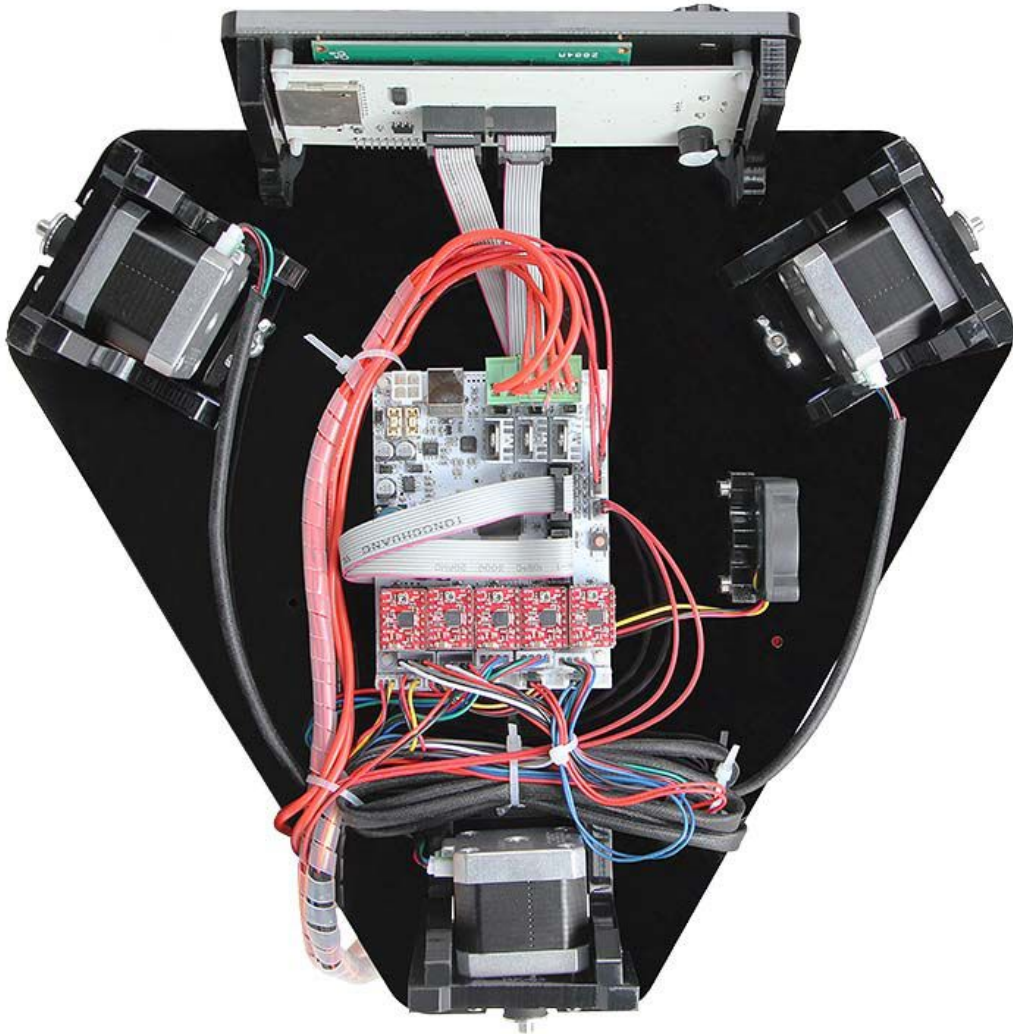

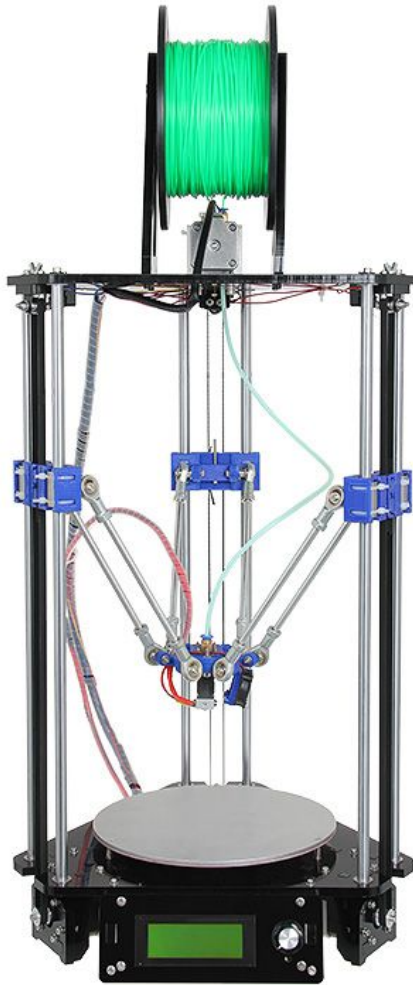

So far, the Rostock mini G2 has been fully assembled.

For detailed instruction of setting up, please refer to [wiki](#).